

# Proxy Benchmarks for Reproducible Research

Prof. Lizy K. John

Email: [ljohn@ece.utexas.edu](mailto:ljohn@ece.utexas.edu)

www: <http://users.ece.utexas.edu/~ljohn>

## Outline

---

- Introduction to Proxy Benchmarks
  - Miniaturization, Software Stack Abstraction, Proprietary Codes
- Metrics, Techniques and Results for early Proxies
  - Bell, Joshi, Ganesan, and Panda Proxies; Results
- SimPoint as an alternative (CPU 2017 SimPoints) – Steven Flolid
- Challenges - Improving Accuracy of Proxy Benchmarks
  - Branch and Memory Behavior – Problem and Current State
  - Presentations by Zachary Susskind and Steven Flolid
- Industry Use
  - Intel – Presentation from Emily Shriver
- ISA Independence - LLVM Proxies
- Reproducibility of Research using Proxies
- Other Applications of Proxy Code Generator

## Introduction

---

- **Bad Press on Early Synthetic Benchmarks**
- Whetstone, Dhrystone
- Misuse of Synthetic Benchmarks
- Not many good memories
- A totally new look at a new kind of synthetic benchmarks
- A few new scenarios
  - **The Pre-Silicon Nightmare**
  - **Proprietary Applications that cannot be shared**
  - **Expiring Benchmarks**
  - **Power and Thermal Stress Benchmarks**

# The Presilicon Design Nightmare

Modern microprocessors are built from millions of lines of VHDL/Verilog code and billions of transistors

RTL and Performance Models are 1000X or more slower than hardware.



Industry standard benchmarks run for hours on actual hardware.

Design tradeoffs need to be analyzed quickly to make timely design decisions.

If the wrong decisions are made, the presilicon nightmare will become a serious

**TPC** Transaction Processing Performance Council

**postsilicon** nightmare

# Methodology: Workload Modeling and Synthesis

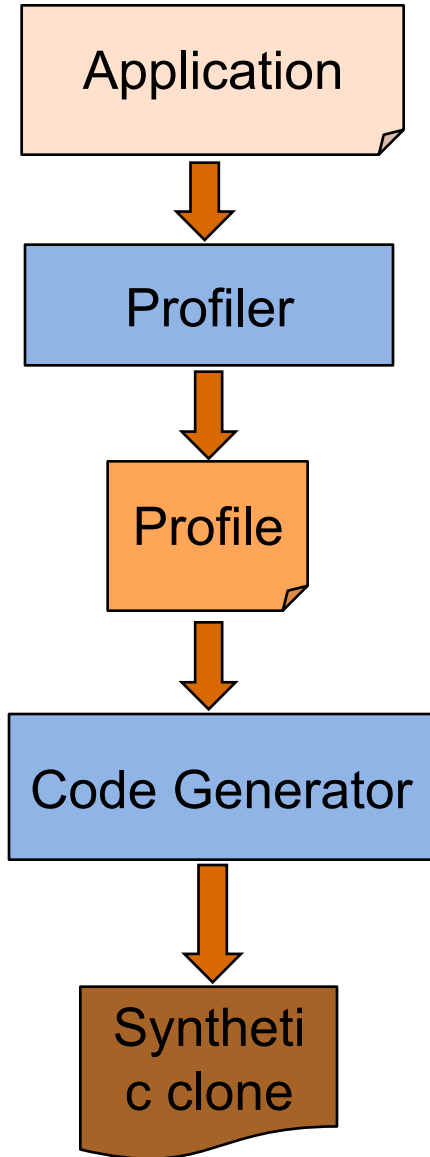

1. **Identify a list of intrinsic properties  $\alpha, \beta, \gamma \dots \omega$  to uniquely describe the behavior of a modern program**
  
2. **Develop a methodology to reproduce the same behavior synthetically**

# Representing a Program with Intrinsic Properties

- **Is it possible to find a list of intrinsic properties  $\alpha, \beta, \gamma, \dots, \omega$  to uniquely describe a program?**
- **What will be the characteristics  $\alpha, \beta, \gamma, \dots, \omega$ ?**
- **Platform (Micro-architecture) Independent Characteristics**
  - i-mix, locality, address patterns, dependency
- **Platform (Micro-architecture) Dependent Characteristics**
  - Cache-hit rates, IPC/throughput, coherency traffic

# Proxy Workload Generation

**Workload Space of Inherent Program Characteristics**

**Modeling Workload Attributes into Synthetic Workload**

**Experiment Environment**

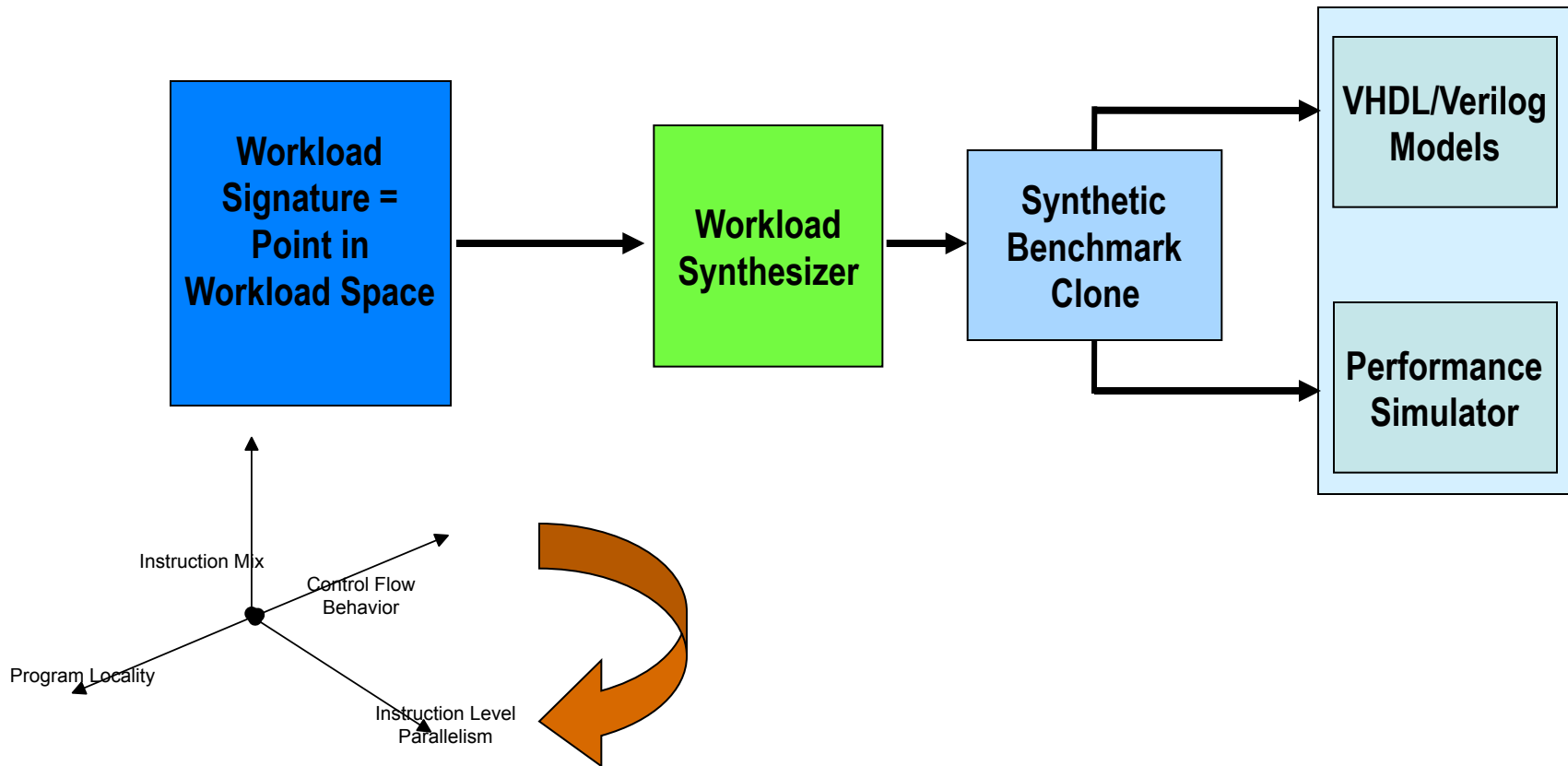

# Miniaturized Proxy Generation Process

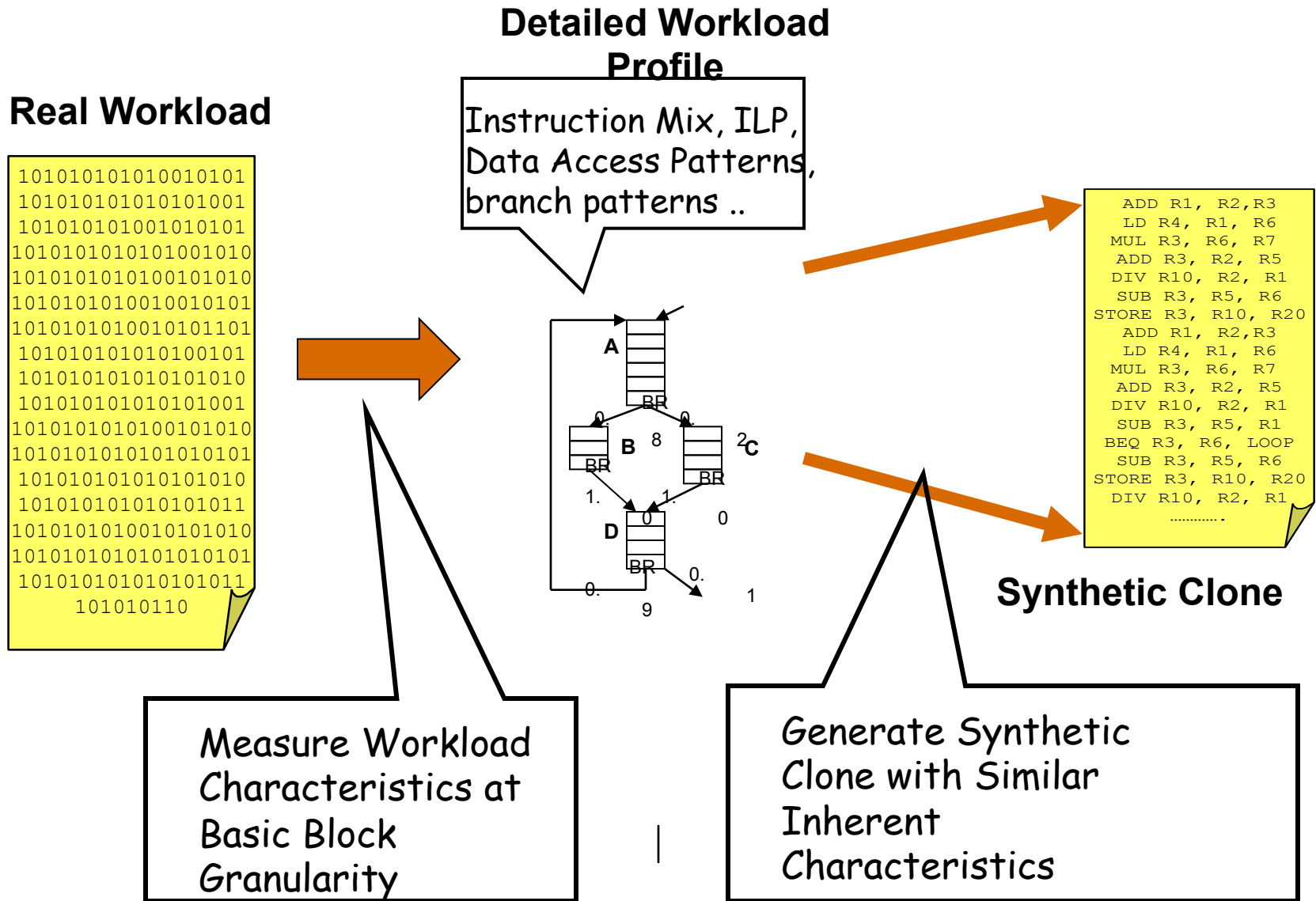



# Steps in Proxy generation

- Generate Workload profile
  - Command: `./mkJSON_both.sh $input $output $output_name.fixed`

- Generate Proxy
  - Command: `./CodeGenerator.py --configFile=$file -o $output`

- Run Proxy
  - Command: `c executable`

# Statistical Flow Graph (SFG)

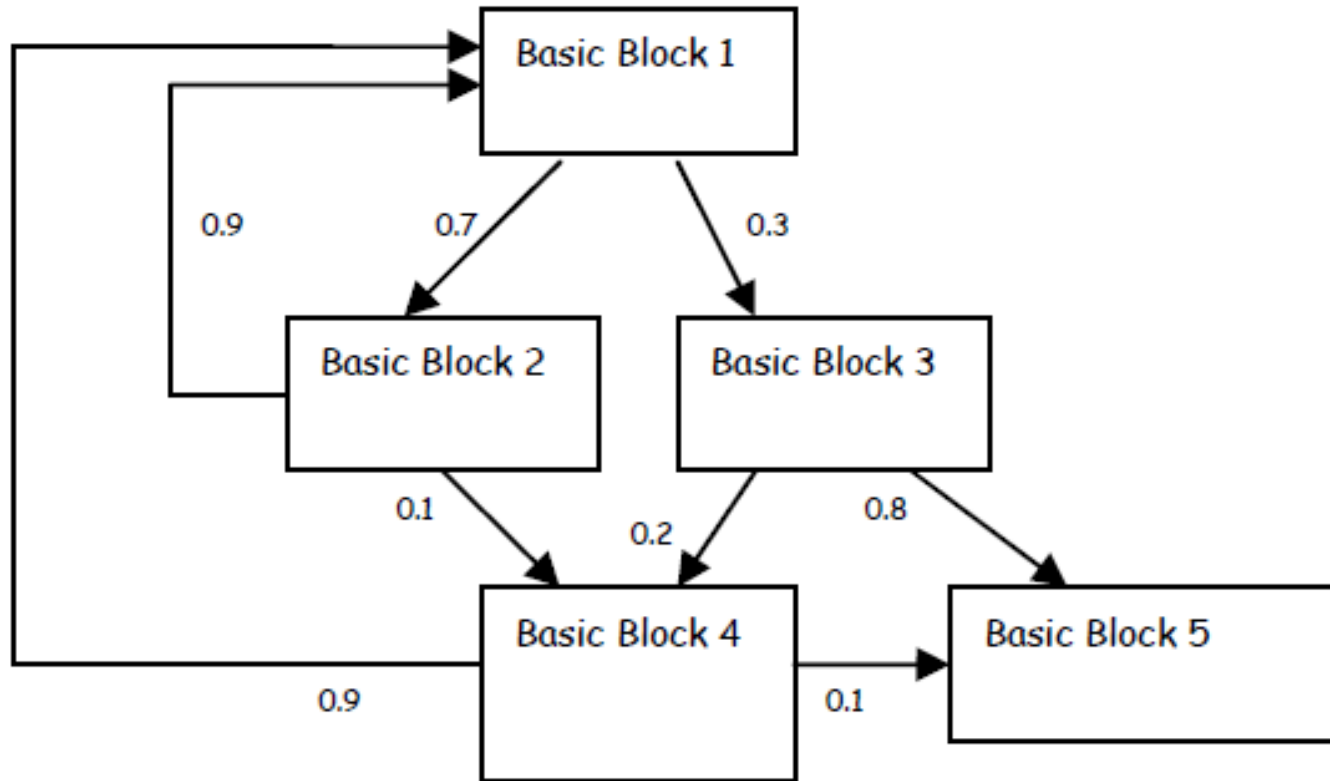

# Profiling the Original Workload

No.	Metric	Category
1	Dynamic execution freq. of basic blocks	Control flow predictability
2	Average basic block size	
3	Branch taken rate for each branch	
4	Instruction pattern in a basic block	
5	Branch transition rate for each branch present in the workload	
6	% Integer multiplication	Instruction mix
7	% Integer division	
8	% FP multiplication	
9	%FP division	
10	% Loads	
11	% Stores	
12	% Branches	Instruction level parallelism
13	Dependency distance distribution per instruction type	
14	Stride value per static load/store	Data locality
15	Data Footprint of the workload	
16	Mean and standard deviation of the MLP	Memory level parallelism
17	Mean number of consecutive dynamic inst. when no outstanding long-latency loads	

# Abstract Workload Model

No.	Metric	Category
1	Basic block size	Control flow predictability
2	Branch taken rate for each branch	
3	Branch transition rate	
4	Proportion of INT ALU, INT MUL, INT DIV, FP ADD, FP MUL, FP DIV, FP MOV, FP SQRT, LOAD & STORE	Instruction mix
5	Dependency distance distribution	Instruction level parallelism
6	Private stride value per static load/store	Data locality
7	Data Footprint of the workload	
8	Mean and standard deviation of the MLP	Memory Level Parallelism (MLP)
9	MLP frequency	
10	Number of threads	Thread level parallelism
11	<b>Thread class and processor assignment</b>	<b>Shared data access pattern and communication characteristics</b>
12	<b>Percentage loads to private data</b>	
13	<b>Percentage loads to read-only data</b>	
14	<b>Percentage migratory loads</b>	
15	<b>Percentage consumer loads</b>	
16	<b>Percentage irregular loads</b>	
17	<b>Percentage stores to private data</b>	
18	<b>Percentage producer stores</b>	
19	<b>Percentage irregular stores</b>	
20	<b>Shared stride value per static load/store</b>	
21	<b>Data pool distribution based on sharing patterns</b>	
22	Number of lock/unlock pairs and	Synchronization Characteristics
23	Number of mutex objects	
24	Number of Instructions between lock and unlock	

# Instruction Dependency Distance

- Instruction level parallelism:
  - Lower dependency distance corresponds to lower ILP and vice versa.

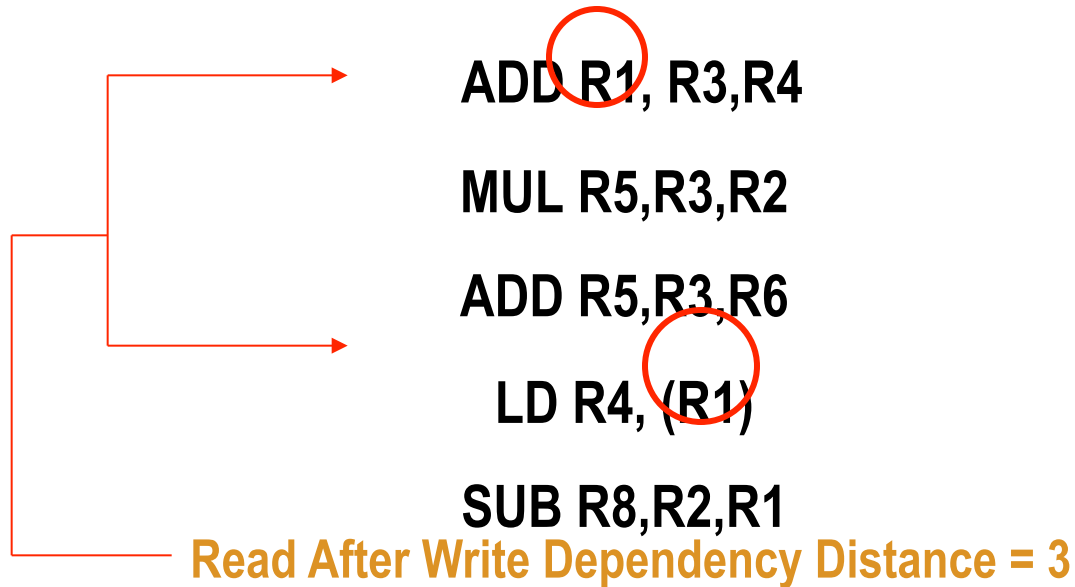

# CFG Information - SPEC CPU2006

Benchmark	No. of B.Blks	# B.Blks for 90% of Prog Exec.	Branch Transition Rate	Average B.Blk Size	Average Number of Succ. B.Blks
CINT 2006					
<b>400.perlbench</b>	<b>1620</b>	<b>169</b>	0.07	5.99	1.93
401.bzip2	93	15	0.06	7.91	1.94
445.gobmk	617	129	0.15	6.97	2.42
456.hmmer	142	12	0.10	8.12	1.49
458.sjeng	281	70	0.17	5.97	2.54
462.libquantum	29	3	0.03	4.59	1.41
<b>464.h264ref</b>	<b>1074</b>	<b>55</b>	0.09	15.13	1.69
471.omnetpp	443	112	0.08	5.25	2.06
473.astar	96	16	0.19	8.77	1.43
483.xalancbmk	62	11	0.00	3.54	2.38
429.mcf	179	96	0.01	10.58	1.21
403.gcc	698	363	0.08	7.14	1.76
CFP 2006					
410.bwaves	32	10	0.26	32.61	1.50
433.milc	42	18	0.44	15.32	1.48
434.zeusmp	48	13	0.02	43.29	1.67
435.gromacs	6	3	0.07	518.06	1.33
436.cactusADM	22	7	0.18	247.16	1.27
<b>437.leslie3d</b>	<b>533</b>	<b>13</b>	0.02	20.43	1.74
444.namd	70	8	0.03	18.95	1.61
450.soplex	358	14	0.03	7.79	1.45
459.GemsFDTD	119	10	0.01	48.81	1.40
482.sphinx3	544	20	0.07	12.76	1.70

# CFG Information – Implant Bench

Benchmark	No. of B.Blks	# B.Blks for 90% of Prog. Exec.	Branch Transition Rate	Average B.Blk Size	Average # of Succ. B.Blks
<b>AI_Adaline</b>	<b>342</b>	<b>6</b>	0.05	39.22	1.63
<b>AI_BPN</b>	<b>410</b>	<b>13</b>	0.06	54.27	1.80
AI_GA	503	160	0.23	7.7	2.26
Bioinformatics_ELO	194	15	0.05	9.42	1.72
Bioinformatics_LMGC	498	111	0.25	7.55	1.91
Genomics_HMM	463	119	0.28	8.03	1.80
Genomics_NJ	196	18	0.17	9.41	2.03
HeartActivity_pNNx	479	97	0.17	6.41	1.68
Physiology_AFVP	679	105	0.26	7.07	1.77
Physiology_ECGSYN	647	142	0.18	8.99	1.65
Reliability_alder32	143	101	0.43	6.81	1.88
Reliability_crc	172	89	0.36	6.1	2.20
Reliability_luhn	155	90	0.40	6.46	2.10
Reliability_reed_solm	255	4	0.02	4.71	1.93
Security_haval	338	82	0.25	8.1	1.94
Security_KHAZAD	198	17	0.14	121.65	1.97
Security_sha2	313	7	0.06	37.32	1.76

- **Dynamic number of instructions varies from hundreds million to few thousands**

# Workload Synthesis Framework

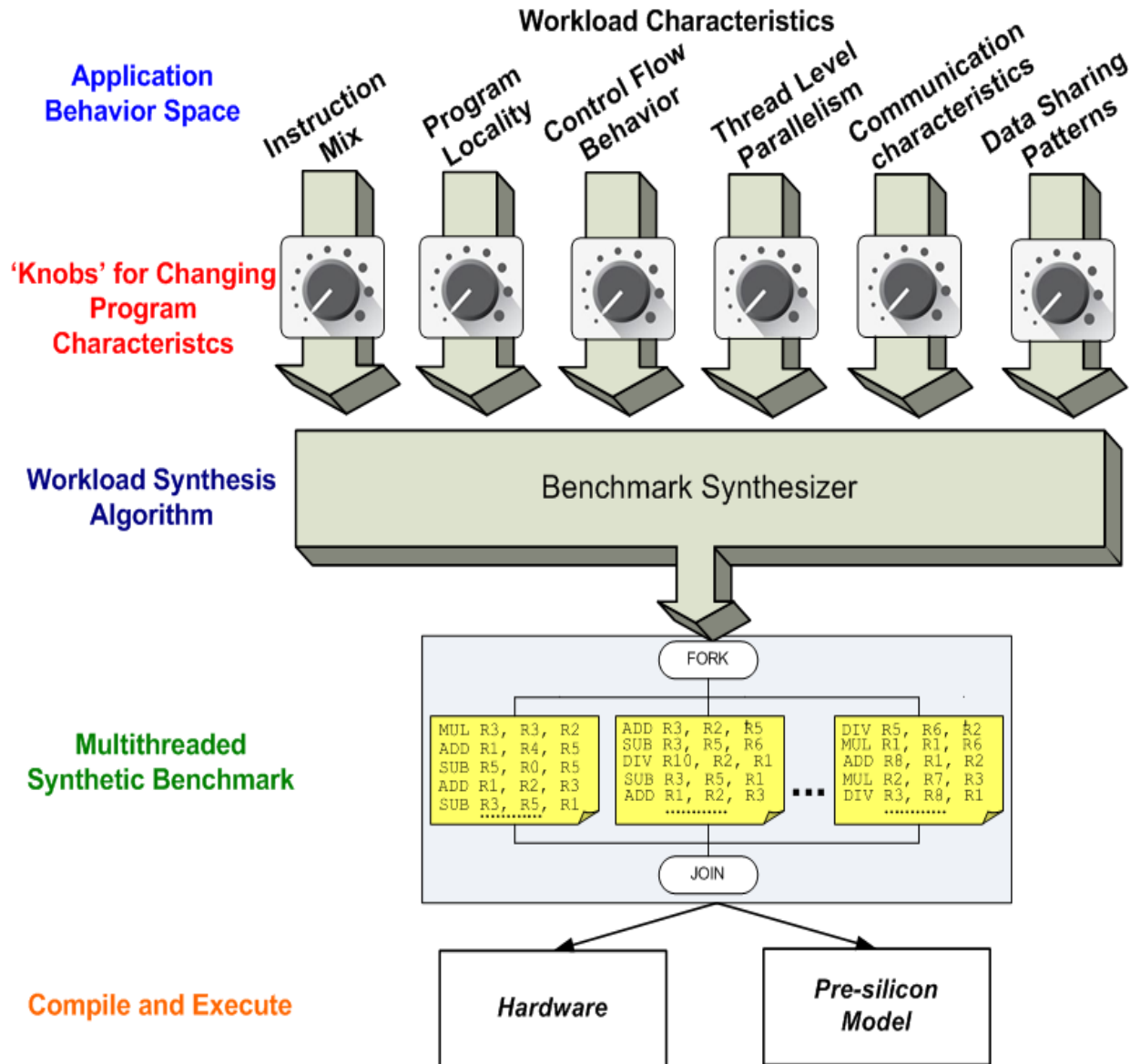



# Workload Synthesis Algorithm

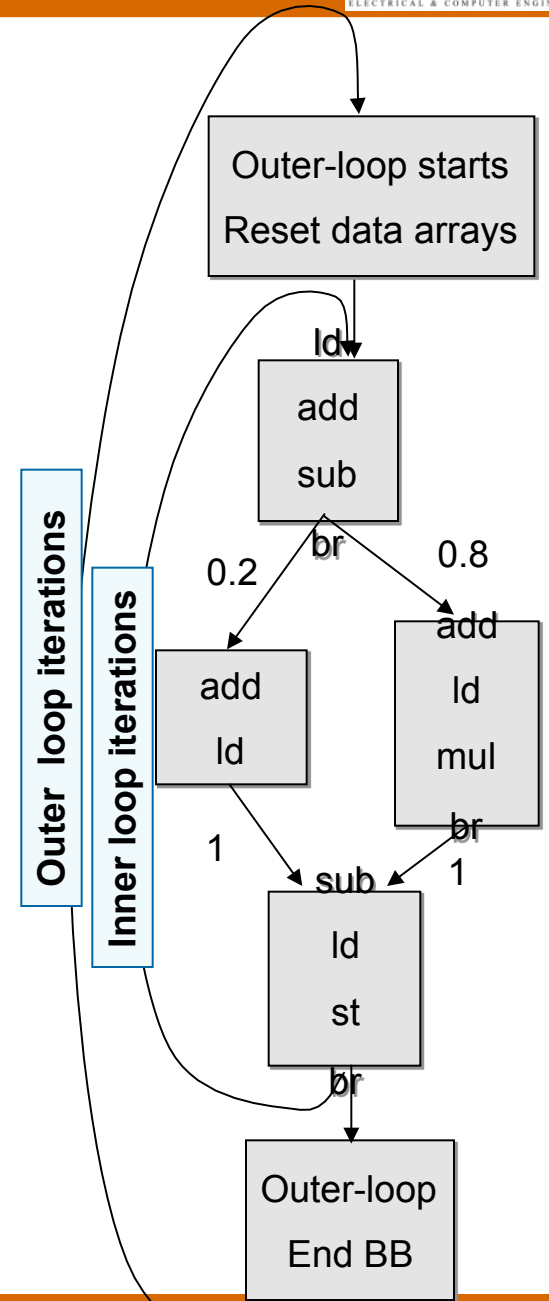
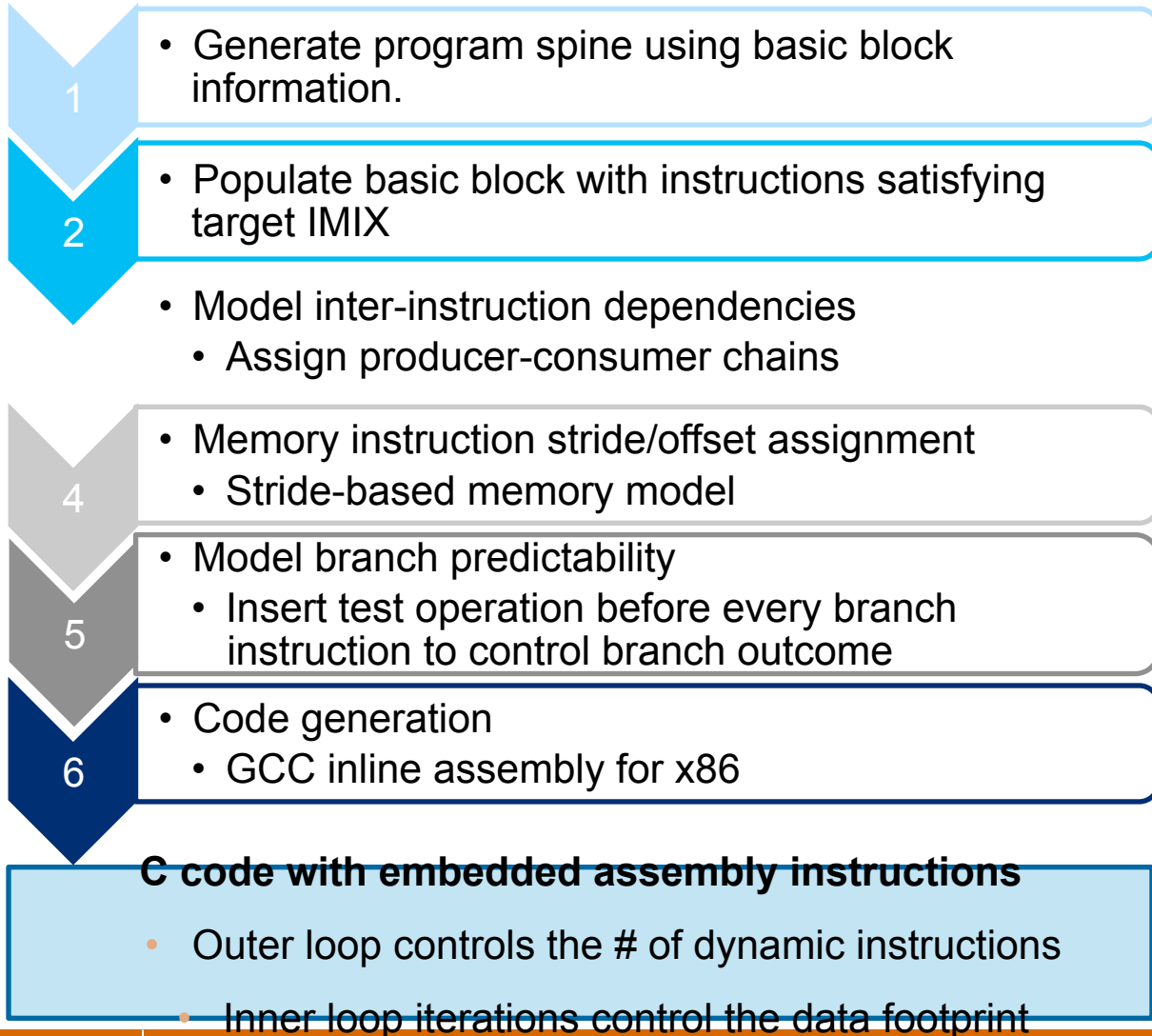

# Code Generation

## Step 1:

- Usage of two loops
- Based on Instruction footprint of original, fix the number of basic blocks in the synthetic

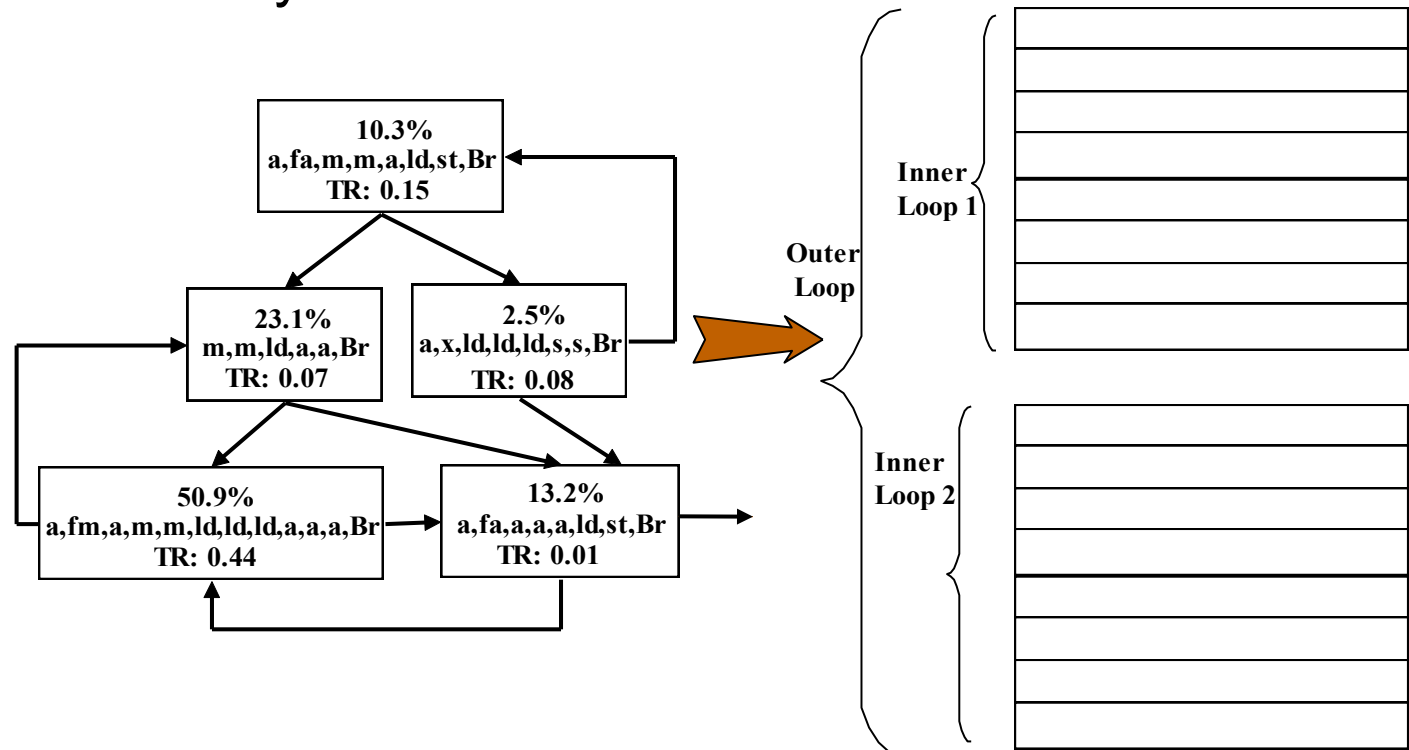

# Code Generation

## Step 2: For each Basic Block

- Choose the instruction pattern from a pool of instruction patterns based on the frequency in the profile in terms of Instruction type
- If not use BB size and global Instruction mix

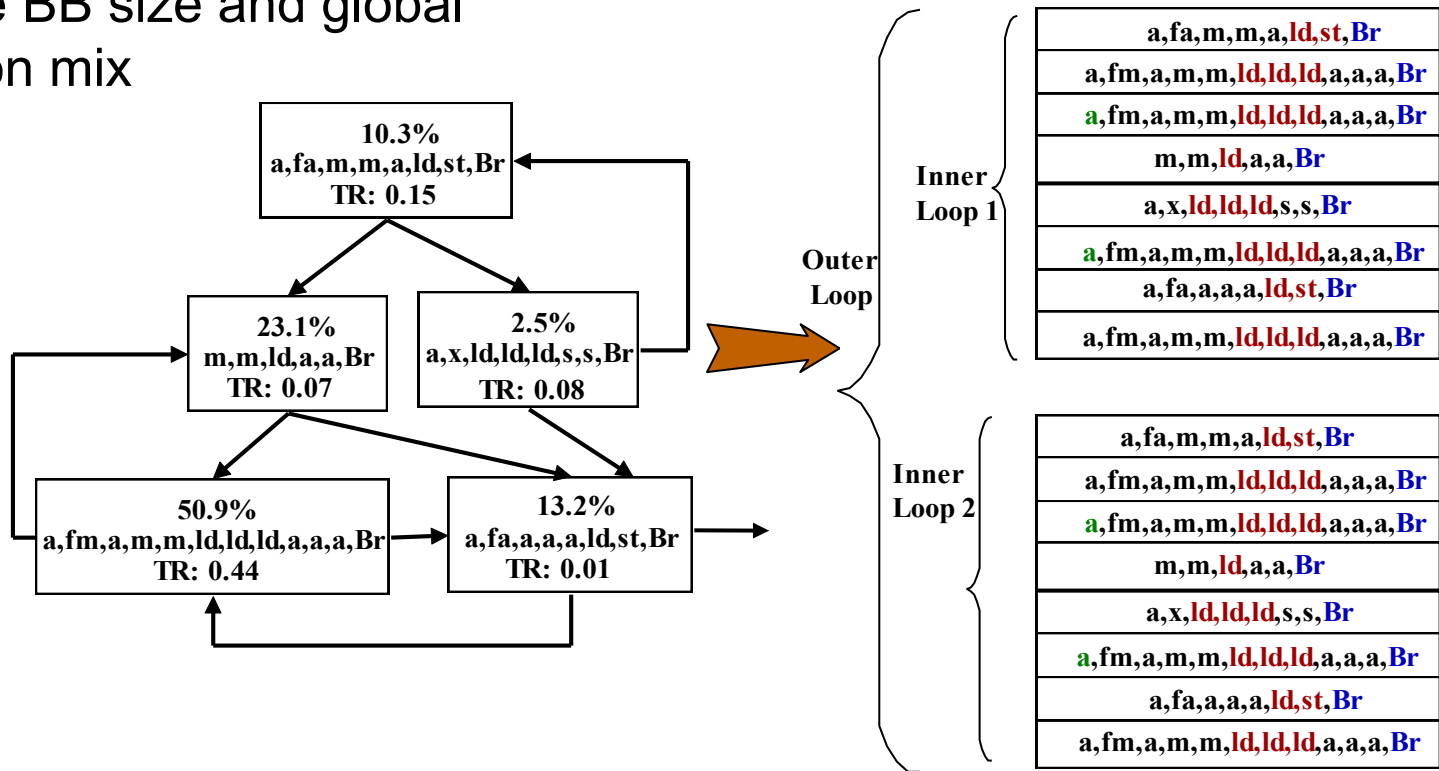

# Code Generation

## Step 3: Bind the basic blocks together using conditional jumps

- Low Transition Rate -> always taken/not taken
- Group into pools & use modulo operations

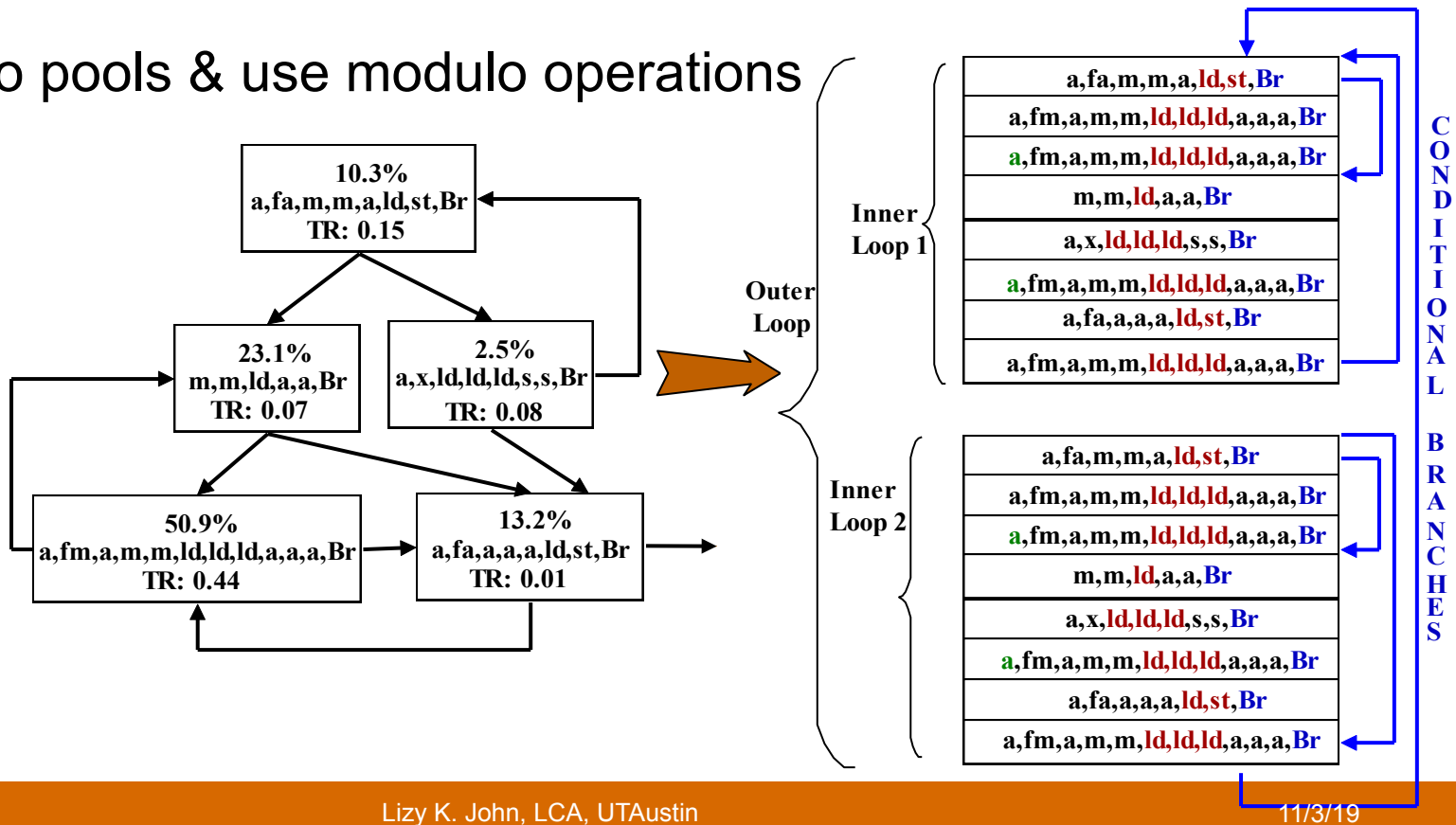

# Code Generation

- **Step 4: For each instruction**
  - Find a producer instn to assign a register dependency
  - Not compatible? Move up/down

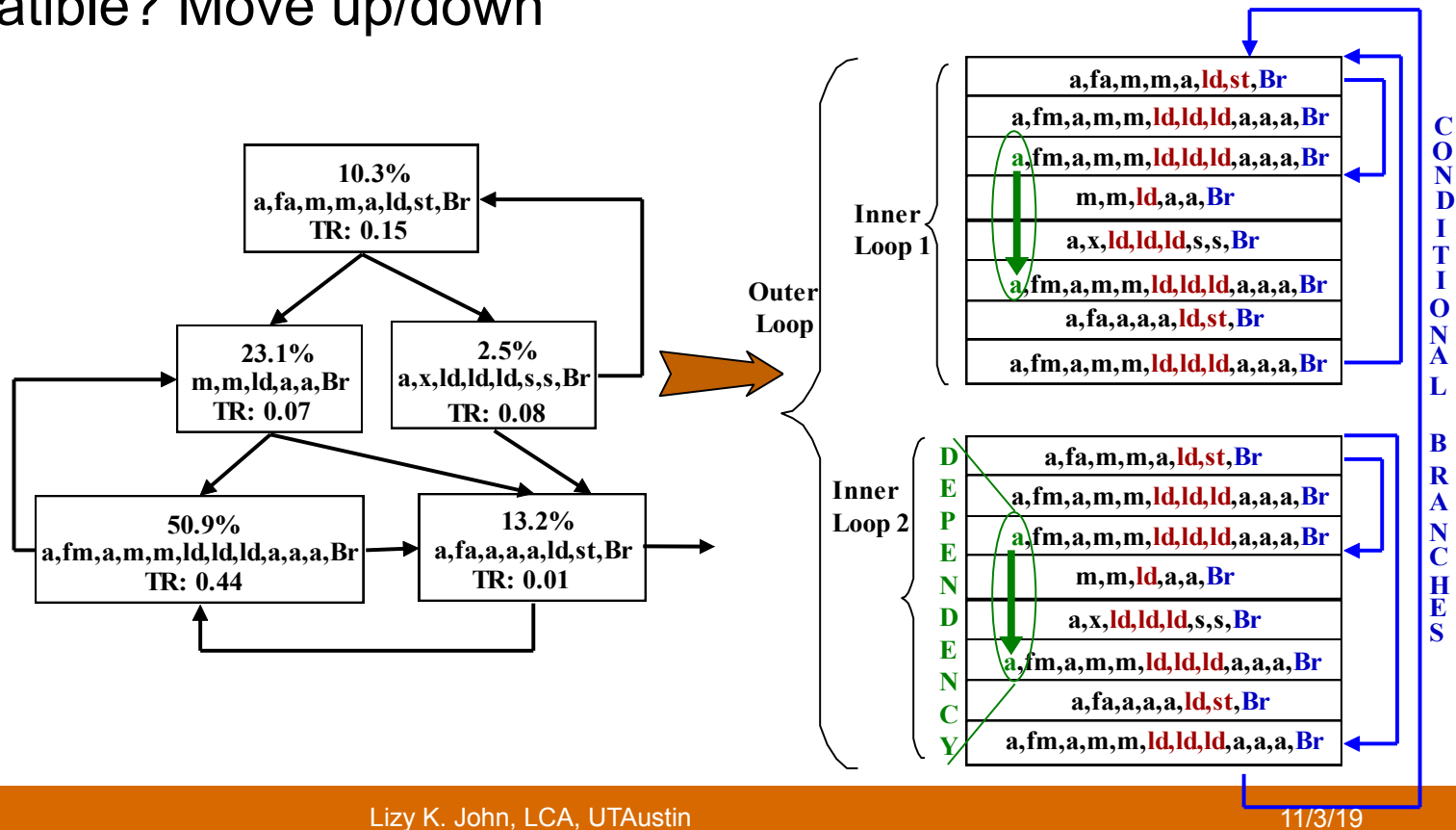

# Code Generation

## Step 5: Assign registers

- Destination registers – RoundRobin
- Source registers – based on dependency

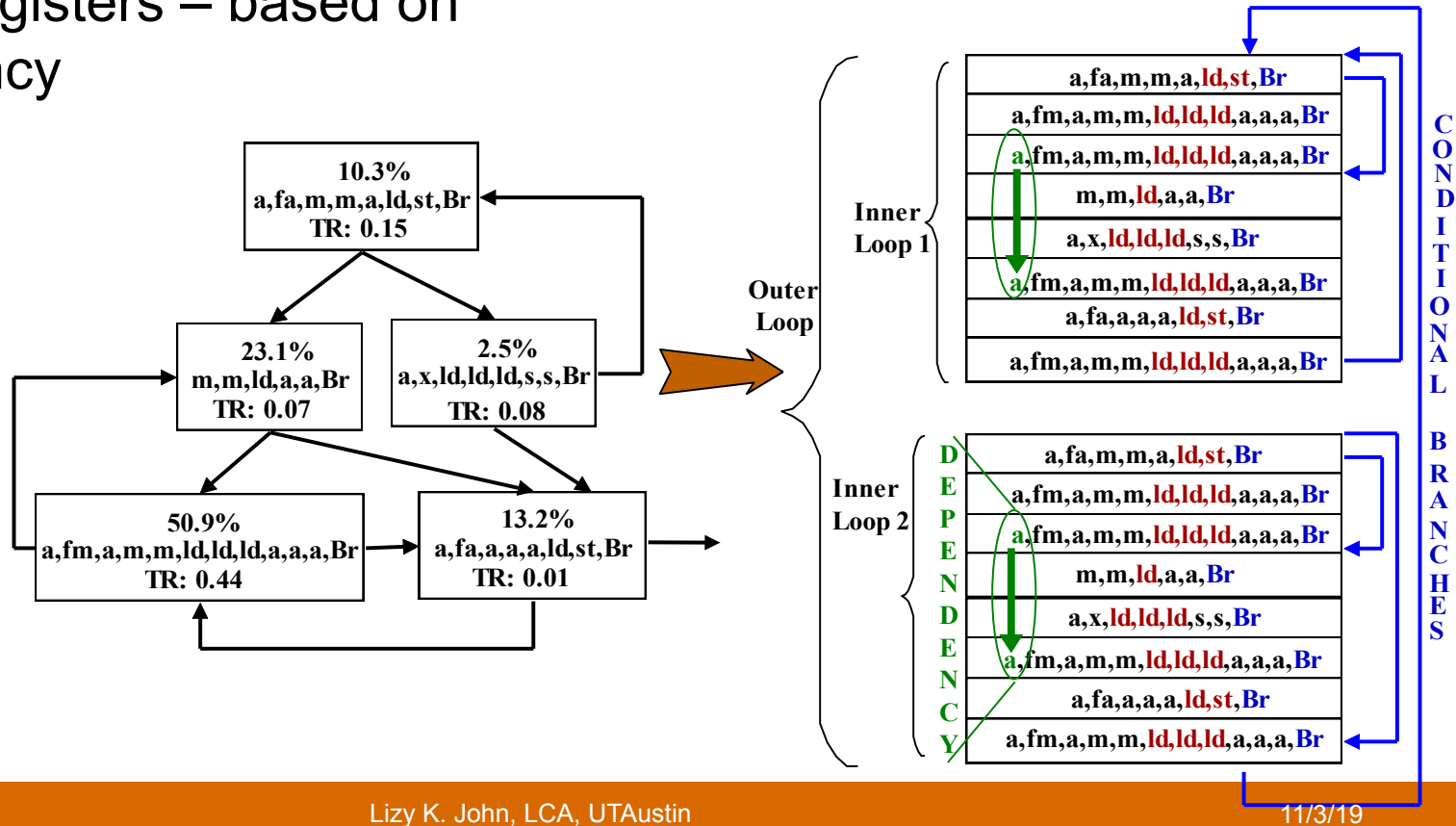

# Code Generation

## Step 6: Memory access model

- Ld/st access a set of 1-D arrays in a strided fashion
- Ld/St - group into pools, assign array, 1 address calc instruction
- Pointers - top of array at end of inner loop when required data footprint is touched

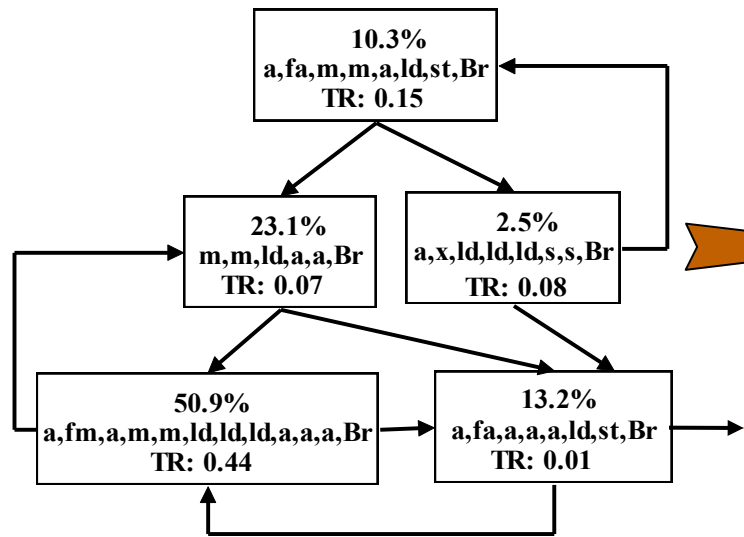
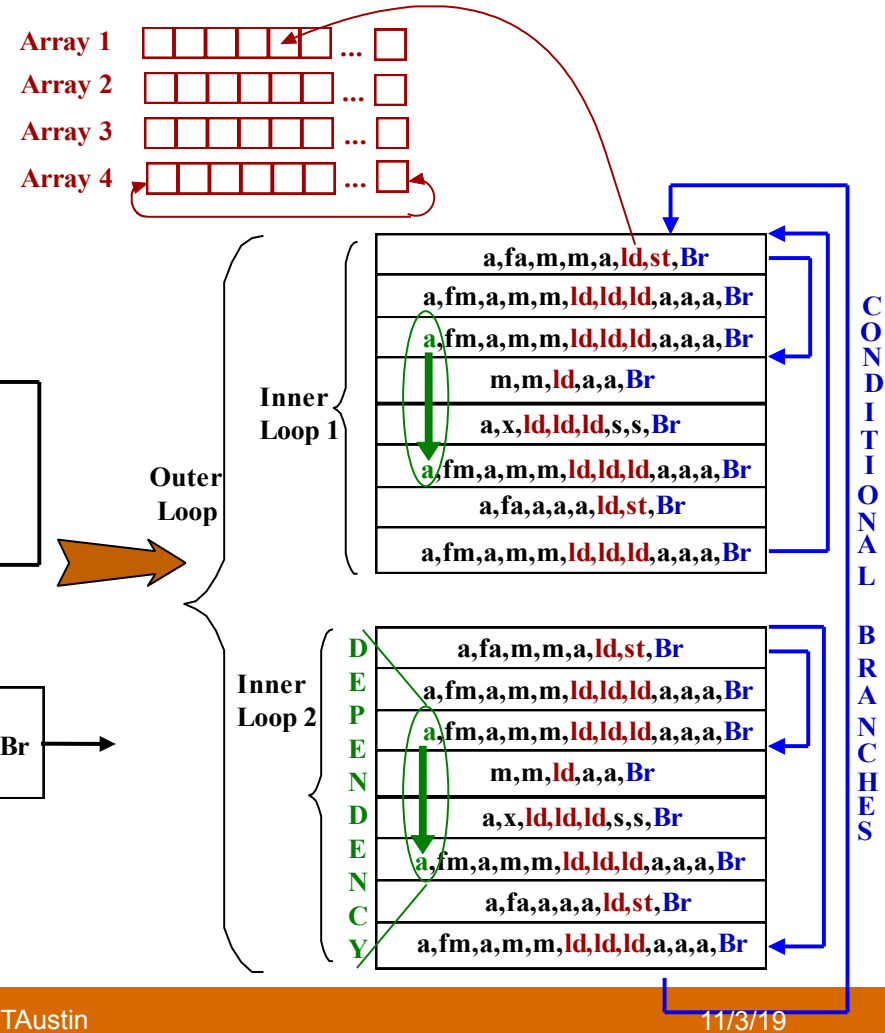

# Code Generation

## Step 6: MLP model

- Load-Load dependencies
- Placement of highly strided loads
- For very infrequent highly bursty long latency loads, only 1 loop has all the long latency loads

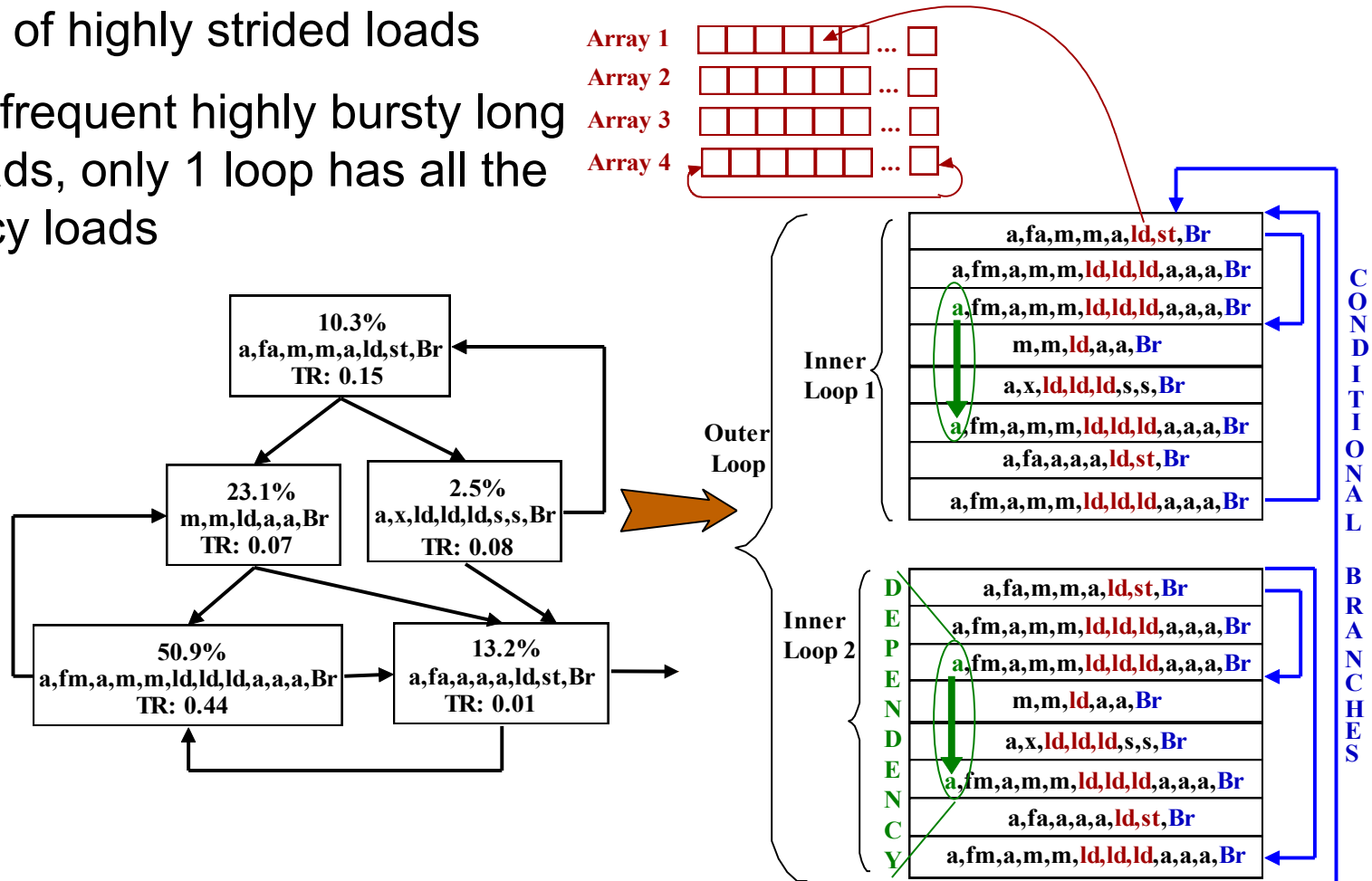



# Performance Results from Early Proxies

Bell: Some microarch dependent metrics;  
Strides computed based on measured cache miss rates

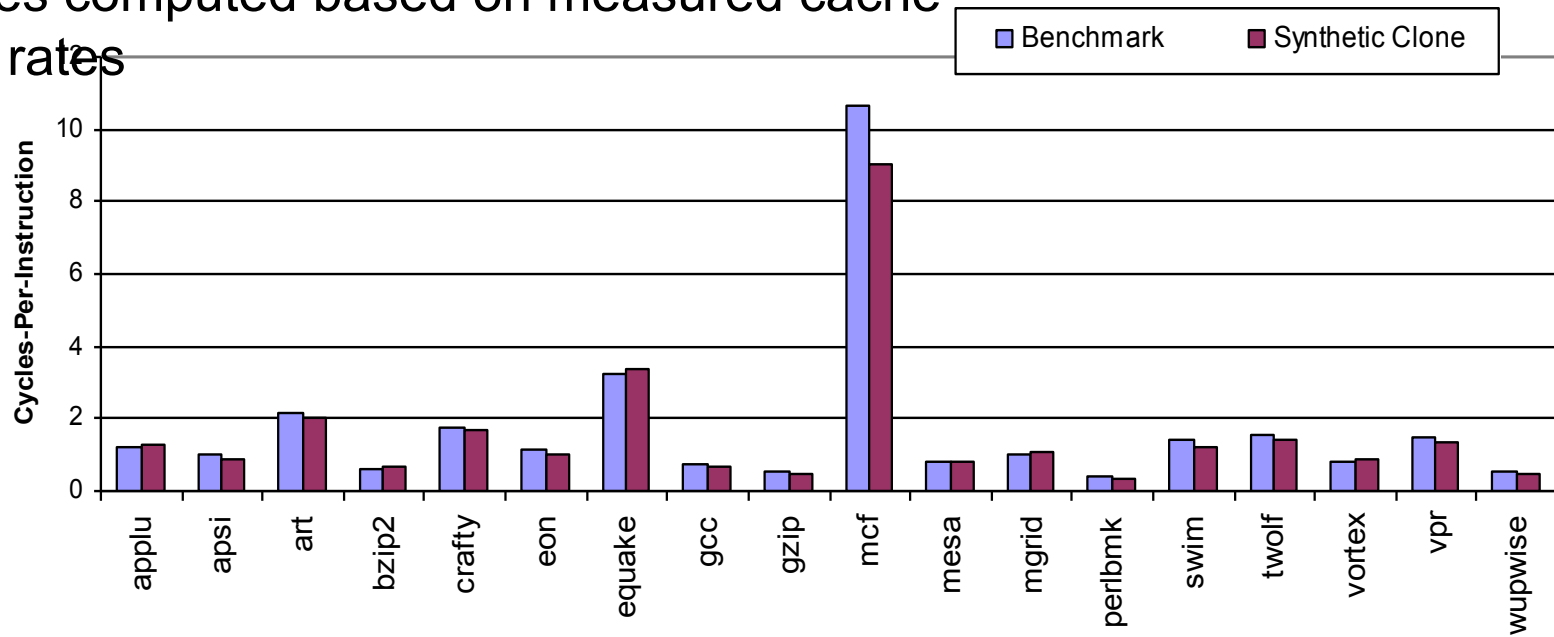

**Average Error of 6.3% & Maximum Error of 9.9% (mcf) [Bell05,06]**

# Overall Power Estimation

## Power Results from Bell Proxies

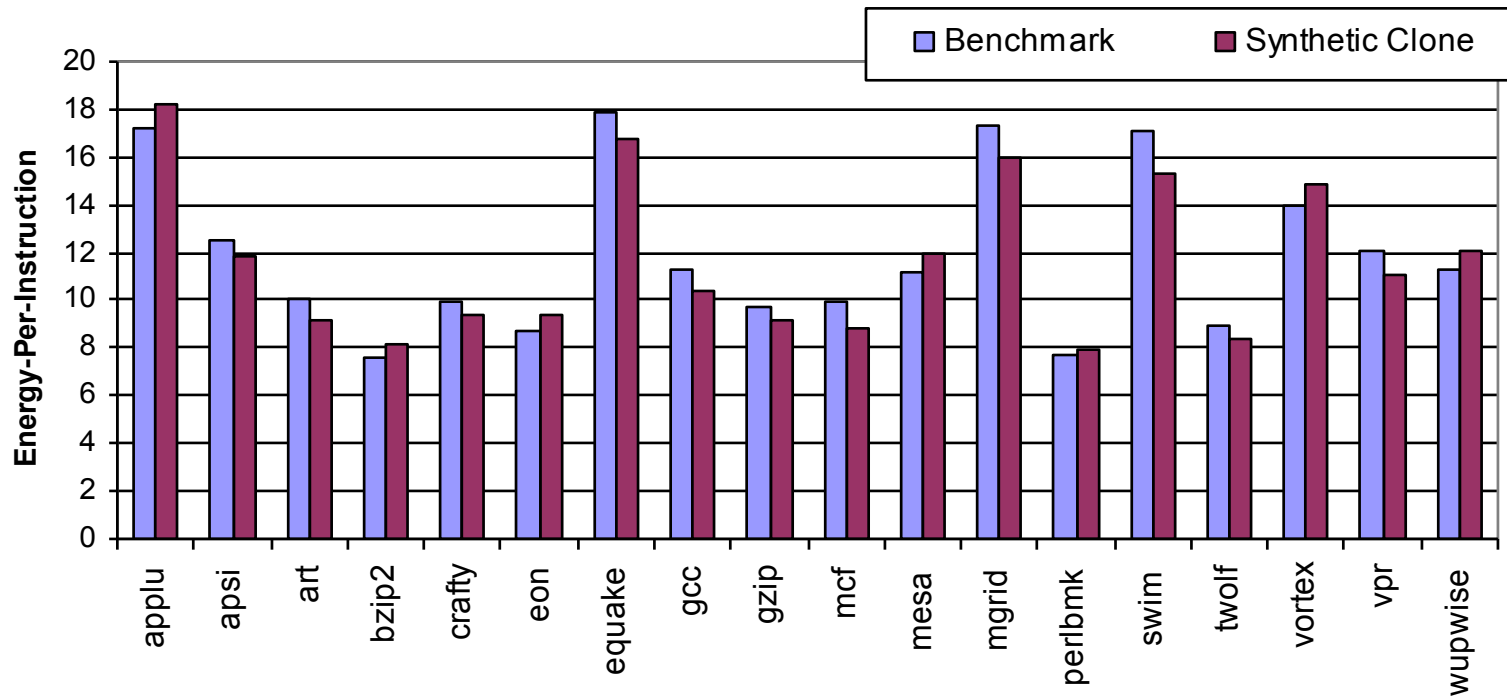

**Average Error of 7.3% & Maximum Error of 10.6% (mcf)**

# Five Orders of Magnitude Speedup!

Benchmark	Speedup from Synthetic Benchmark Clone
<b>Applu</b>	22,300
<b>apsi</b>	34,700
<b>art</b>	4,500
<b>bzip2</b>	12,800
<b>crafty</b>	19,100
<b>eon</b>	8,000
<b>equake</b>	13,100
<b>gcc</b>	4,600
<b>gzip</b>	10,300
<b>mcf</b>	6,100
<b>mesa</b>	14,100
<b>mgrid</b>	41,900
<b>swim</b>	22,500
<b>twolf</b>	34,600
<b>vortex</b>	11,800
<b>vpr</b>	8,400
<b>wupwise</b>	34,900

## Improvements from Joshi and Ganesan

---

- Joshi added the following metrics:
  - Branch Transition Rate
  - Data Reuse Distance
- Ganesan added the following metrics:
  - MLP (Memory Level Parallelism)
  - Parallel Code Data sharing and Synchronization Metrics

## Previous approaches and Memory Level Parallelism

- Existing synthetic workload generation methodologies Joshi et al [IISWC 06], Bell et al [ISPASS '06, ICS '05]
  - Capture control flow, cache access and ILP behavior
  - Do not capture the burstiness of long-latency loads or the Memory Level Parallelism (MLP)
  - May still match the missrate of the original, but not the performance

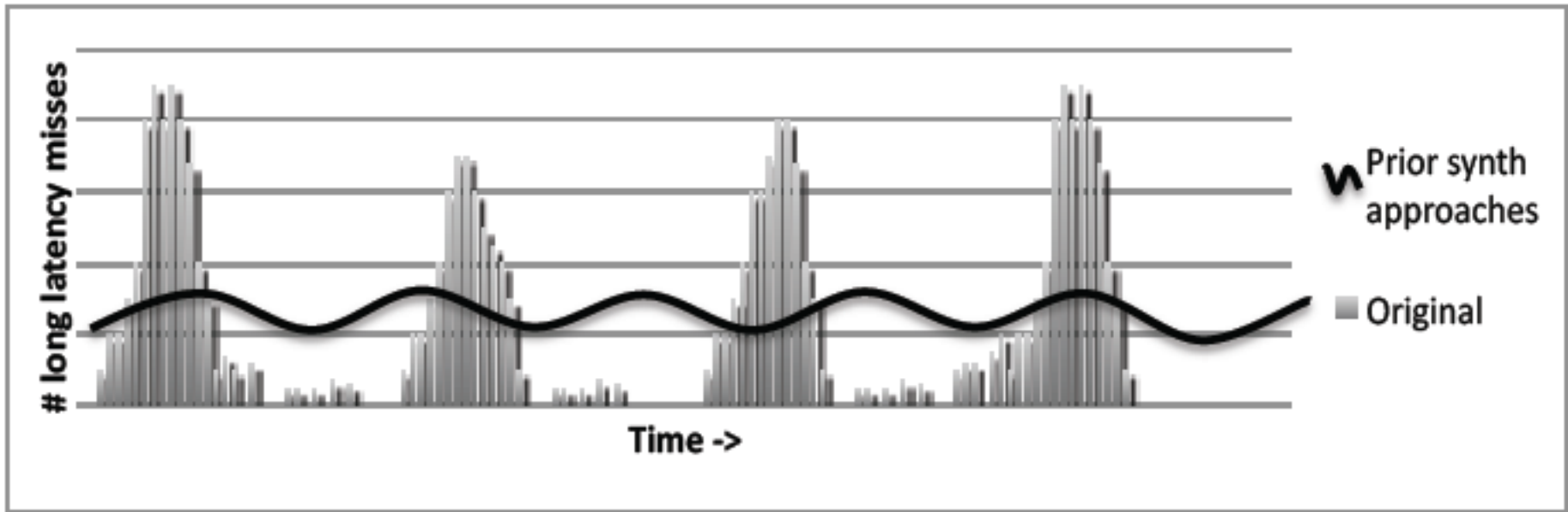

# Memory Level Parallelism

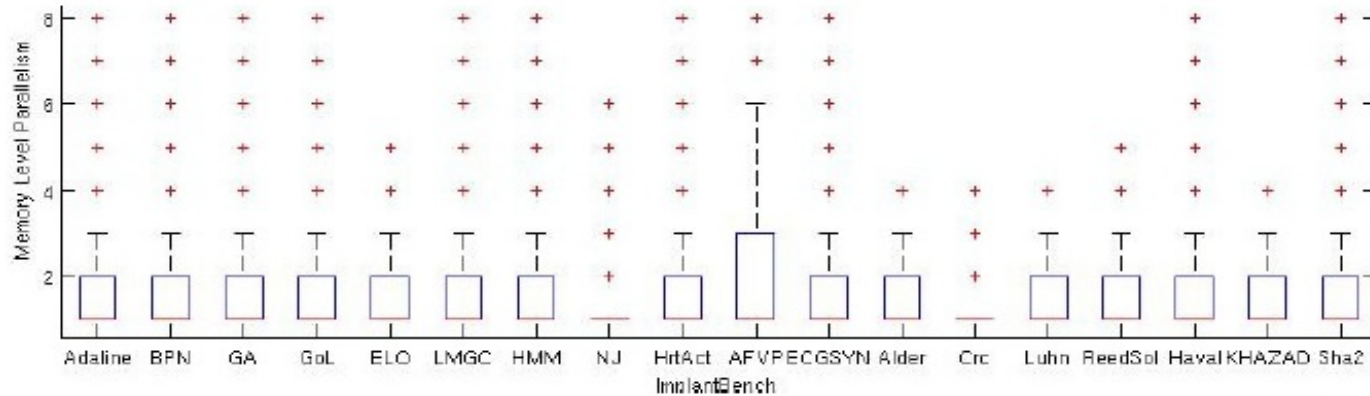
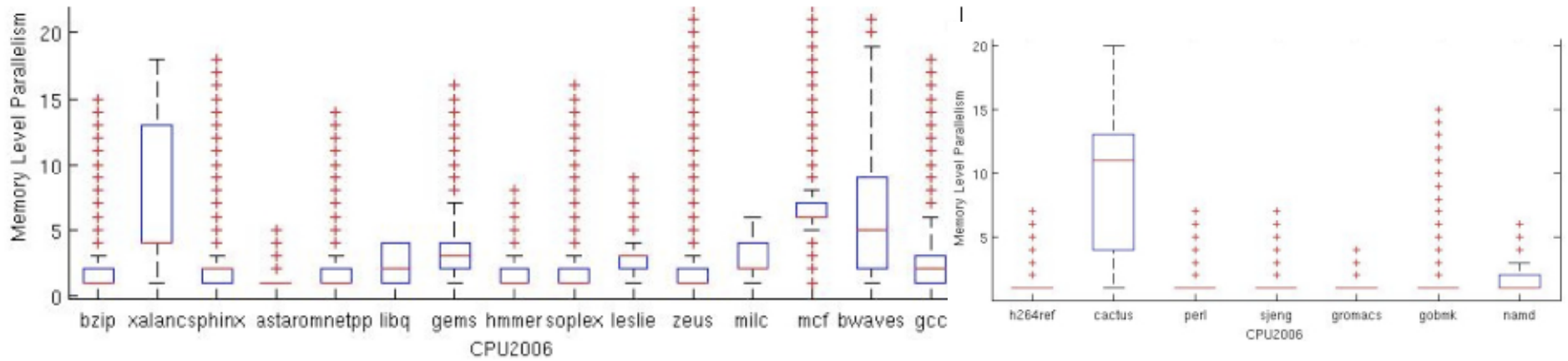

# IPC Comparison – SPEC CPU2006

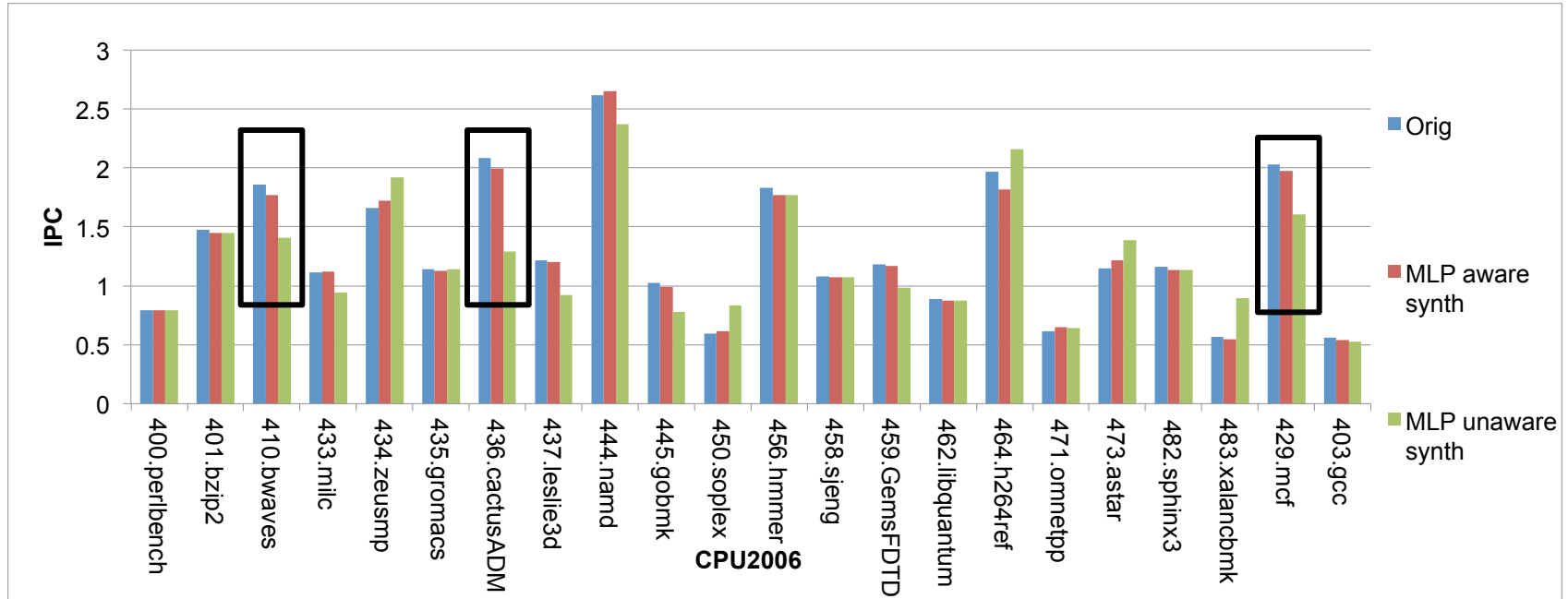

- MLP Aware - Avg = 2.8%, Max = 7.7% for 464.h264ref
- MLP Unaware – Avg = 15.3%

# IPC Comparison – ImplantBench

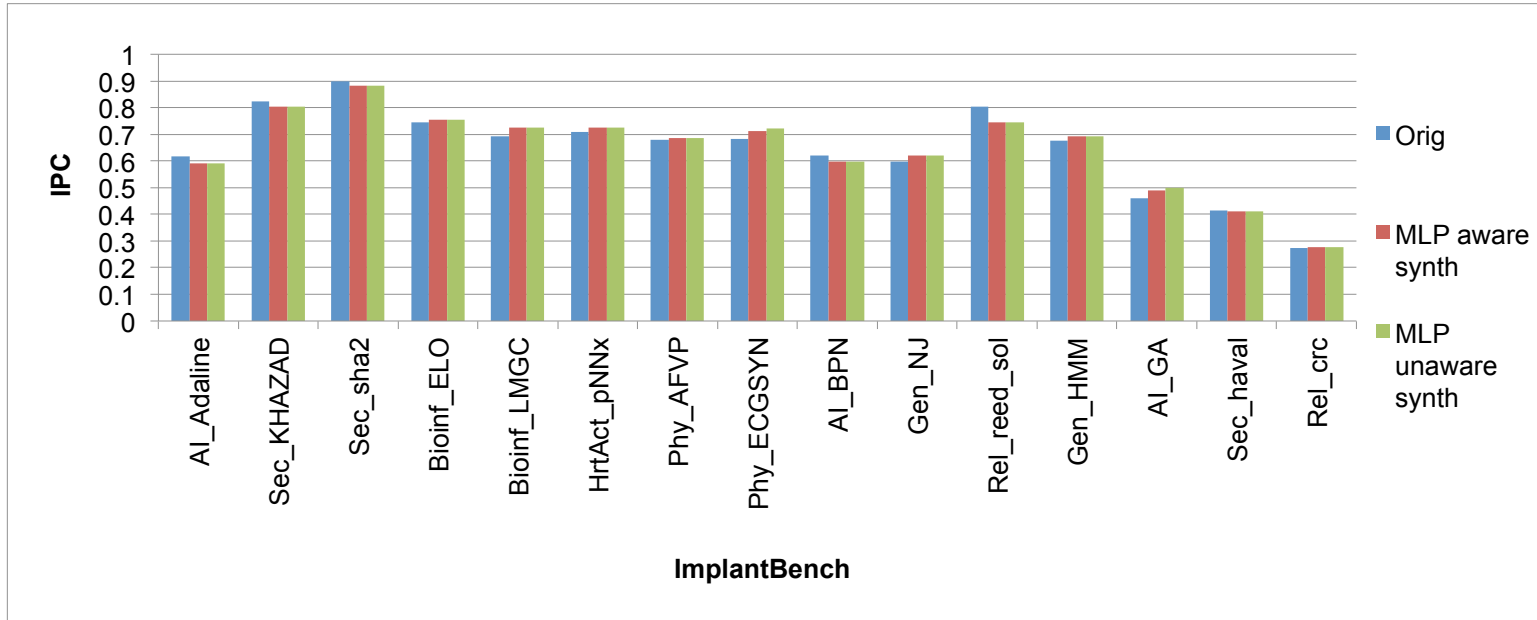

■ Avg = 2.9%, Max = 7.2%



# Power Comparison

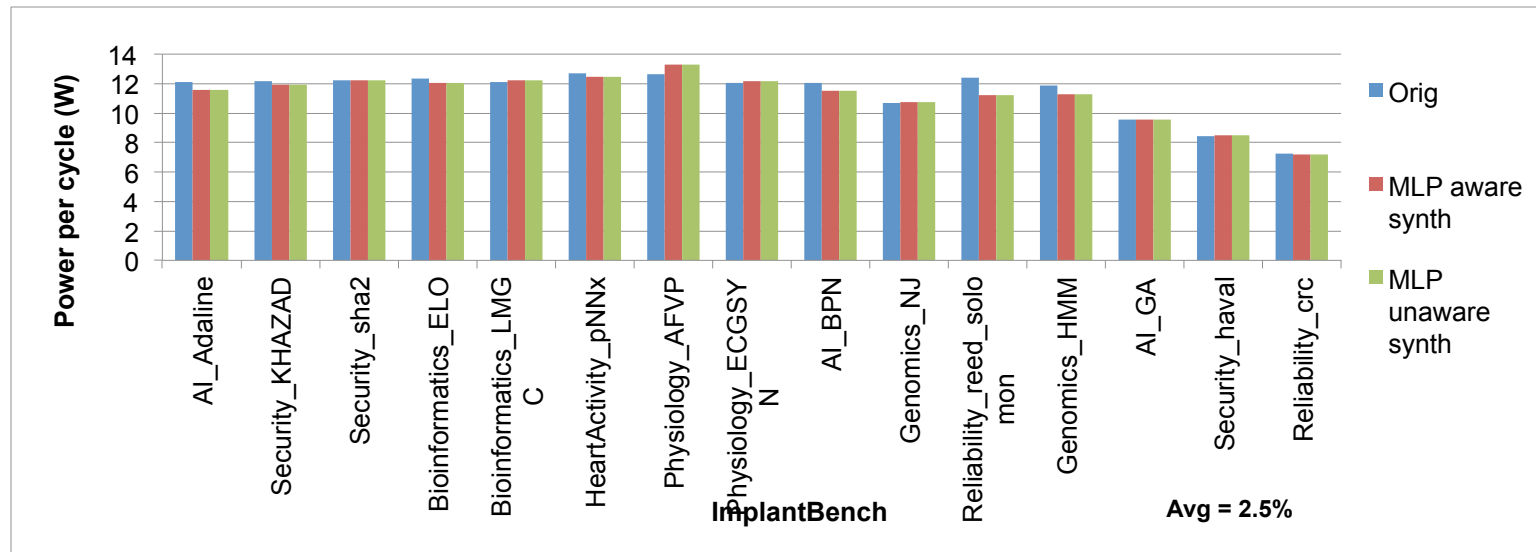
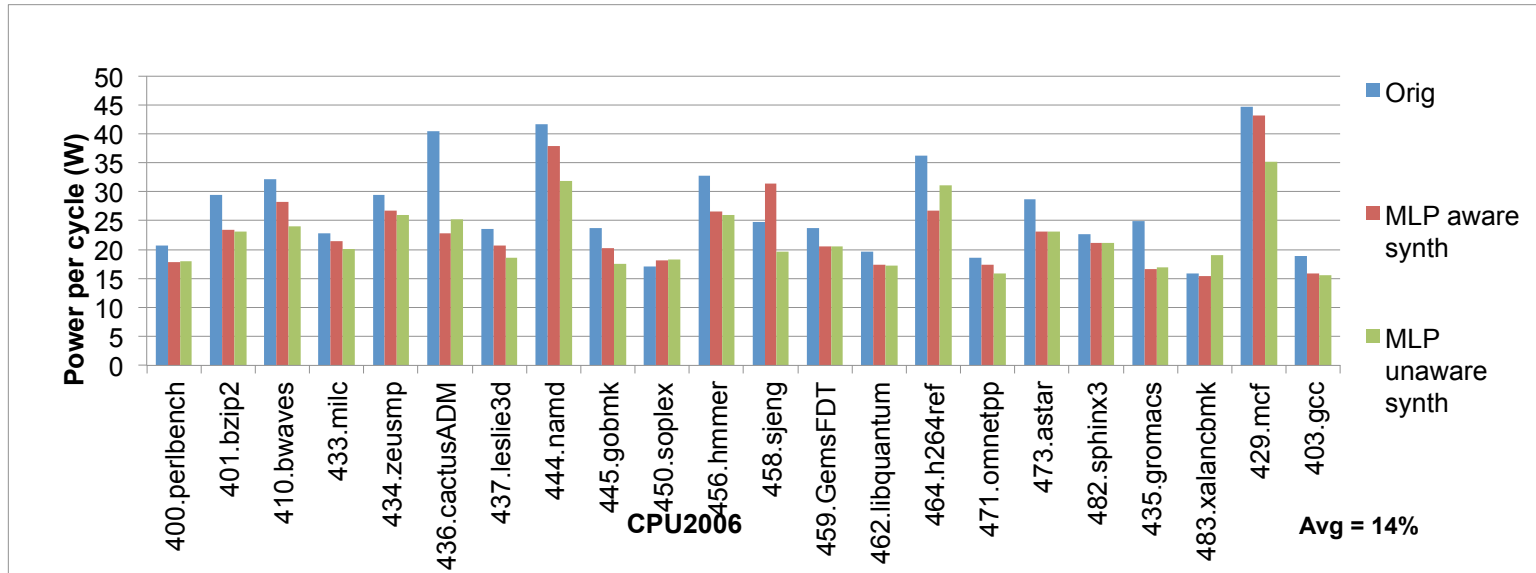

# Relative IPC Accuracy for CINT2006 Benchmarks

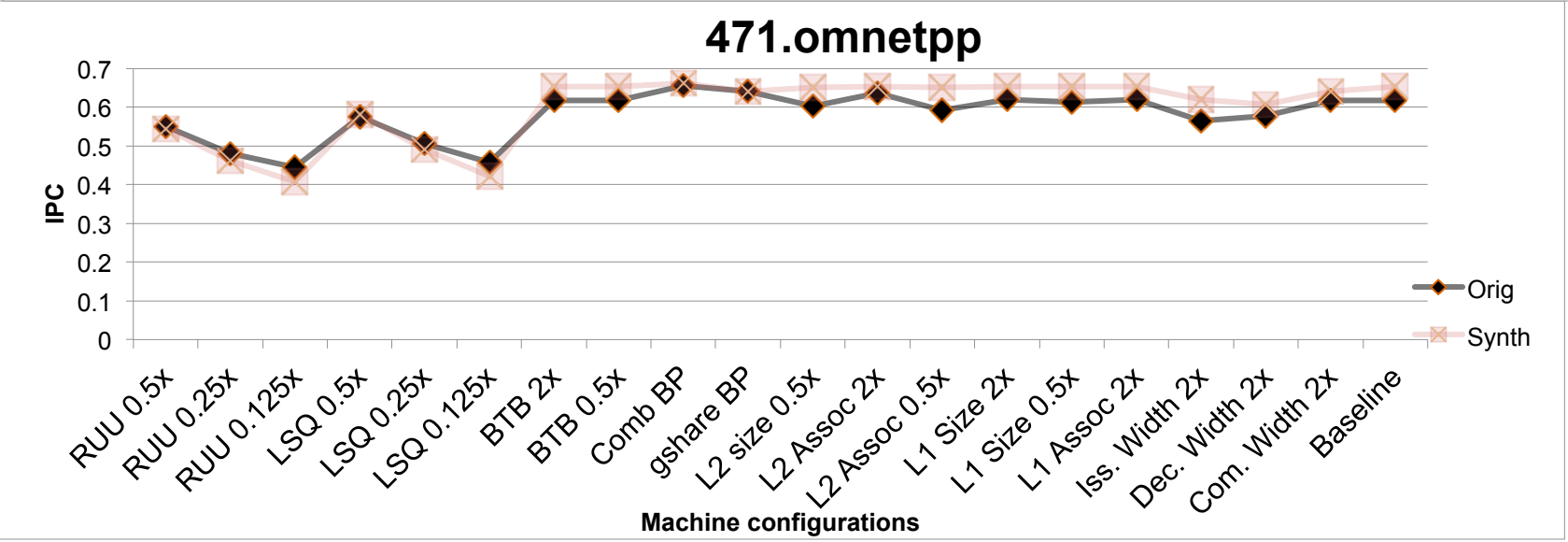
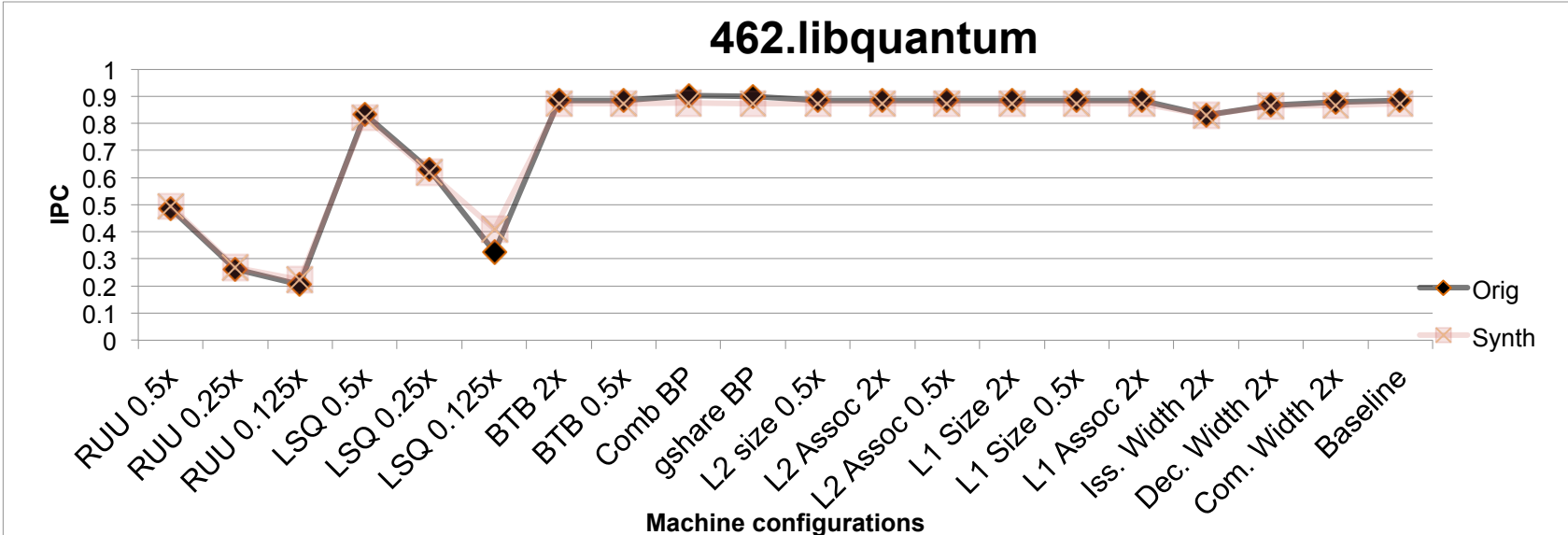

# Relative Power Accuracy for CPU2006

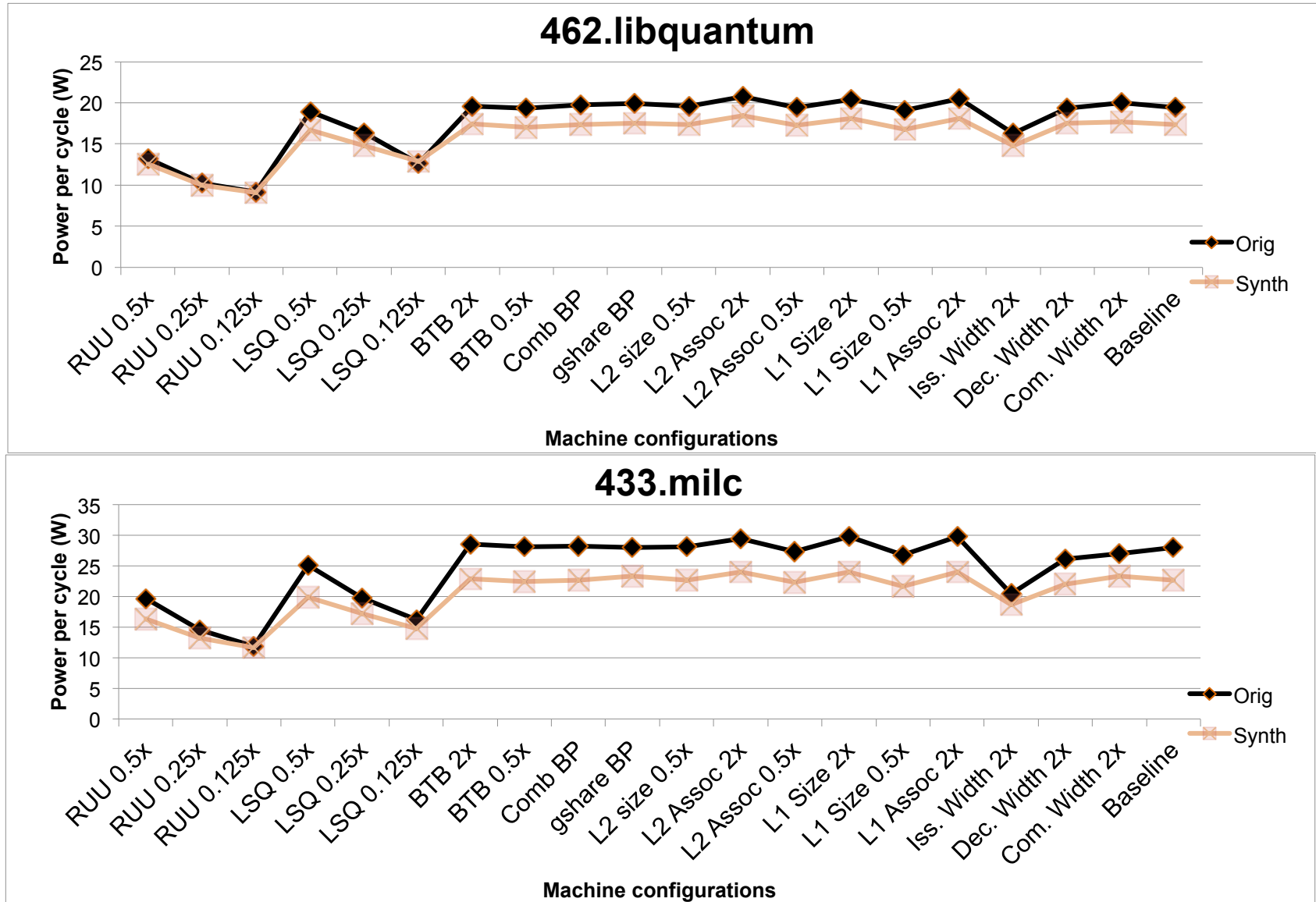

# Simulation Time Reduction

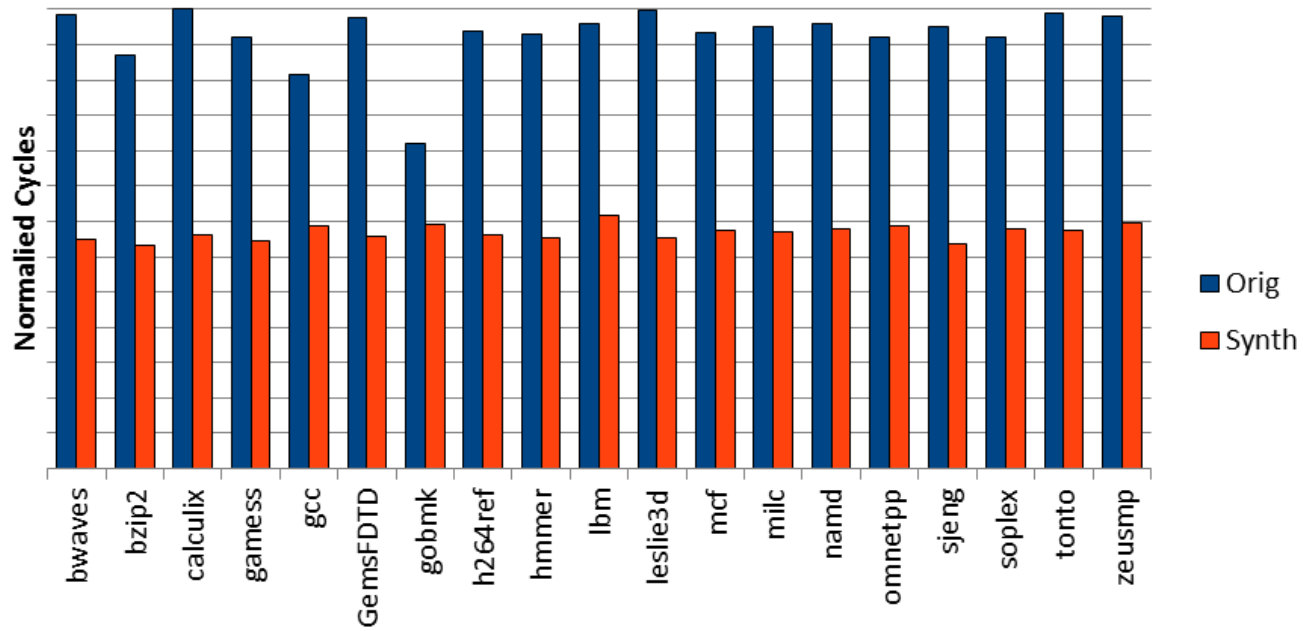

# Performance Proxies for Big Data Workloads

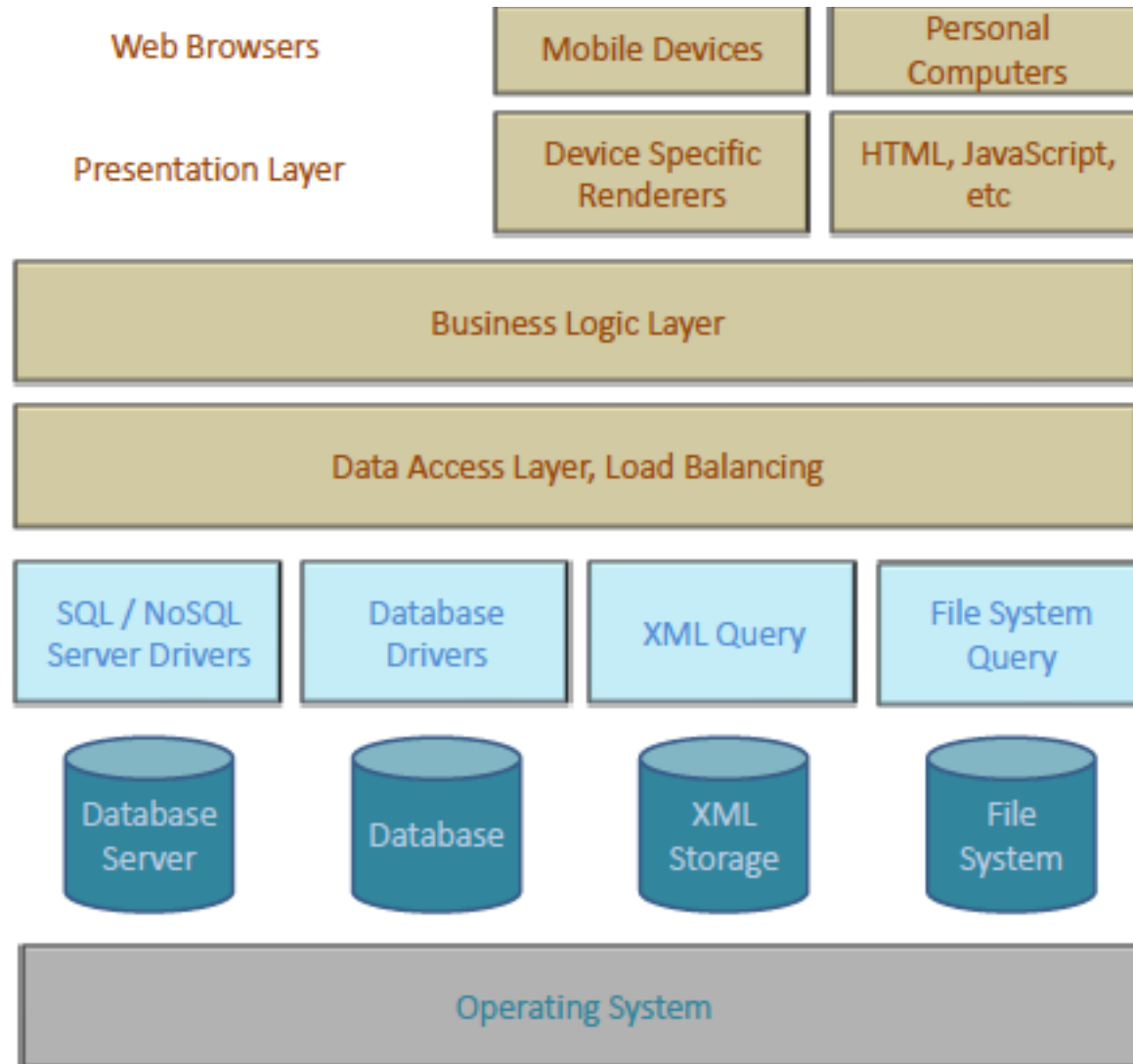

# Instruction-level Profiling Impractical; Estimate METRICS from Perf Counters

- **Instruction-mix**
  - Measured using hardware performance counters
  - Fraction of integer (INT) ALU, INT MUL, INT DIV, floating-point (FP) ADD, FP DIV, FP MUL, loads, stores, control-flow instructions.
- **Instruction footprint**
  - Derived based on the instruction cache miss rate of the original application on a default instruction cache size (64KB, 64B line-size, 2-way set-associative).
- **Average basic-block size**
  - Estimated based on the instruction count and control instruction mix metrics.

# Instruction-level METRIC Estimation (Contd)

- Instruction level parallelism:

- Modeled by controlling the dependency distance (DD) between instructions.
- Lower dependency distance corresponds to lower ILP and vice versa.



- Avg DD estimated based on the fraction of dependency-related stall events (measured using hardware performance counters) of an application.

# Memory-access characteristics

- Original approach – PIN-based memory locality characterization
  - Local Stride - Per Id/st stride distribution
  - Global Stride – Stride distribution of the global memory access streams
- Perf Counter Approach: Strides estimated based on the data cache miss rates of the original application.
  - E.g., 50% hit-rates can be modeled using a stride of 8 (assuming 64B cache-line size)



# CONTROL-FLOW BEHAVIOR

- Branch predictability (BP) of the original application is measured using the branch prediction rate.
- A branch instruction's predictability can be controlled using its transition frequency.

**Branch Transition Rate = *# of Taken–Not Taken transitions / # of times executed***

- PerfProx estimates the fraction of control instructions in the proxy benchmark that will have a particular predictability behavior.

Find the set of  $f_i$  such that

$$BP = f_1 * 1 + f_2 * 0.5 + f_3 * 0.33 + \dots$$

- Assuming a 2-bit saturating counter based branch predictor,  $f_1$ ,  $f_2$ ,  $f_3$  ... are the fraction of branches with 100% (TTTTTTTT or NNNNNNNN), 50% (TNTNTNTN), 33% (TTNTTNTN) predictability respectively.

# System CALL Activity

- Many emerging big-data applications spend a significant fraction of their execution time (upto 30%) executing operating system (OS) code.
- System activity monitored using *STRACE* tool and the fraction of user-mode and kernel-mode instructions using hardware performance counters.
- Modeled by inserting target fraction of system calls into the basic blocks in the proxy benchmark.

# DATABASE PROXY EVALUATION

- Databases - Cassandra, MongoDB and MySQL
- Benchmarks
  - Data analytics (TPC-H Benchmarks) - 10GB, Full runs of Q1, Q3, Q6, Q14 and Q19.
  - Data serving (Yahoo! Cloud Serving Benchmark, YCSB) – 12GB, 100 Million operations.
- Performance monitoring performed on real systems using Linux Perf tool.
- Average instruction-count of the generated proxy benchmarks is ~2 billion (~520 times smaller than original database applications).

Configuration	System-A	System-B
Core Architecture	64-bit processor, Core micro-architecture	64-bit processor, Ivy-bridge micro-architecture
Core Frequency	2 GHz	2.50 GHz
Cache Configuration	Private L1 caches (64 KB I and D caches), 12 MB L2 cache	Three levels of caches, 1.5MB L2, 15MB L3 cache
Memory	16 GB DRAM	64 GB DRAM

# Performance VALIDATION ON system-A (IPC)

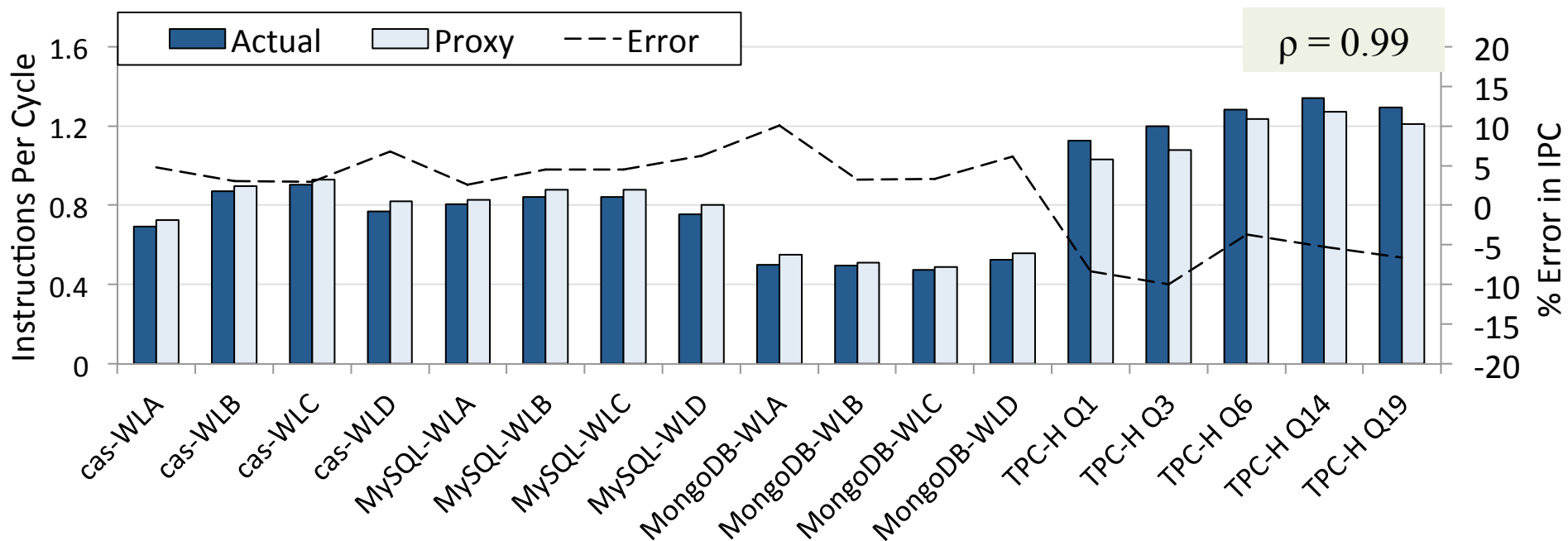

The proxy benchmarks mimic the IPC of the original applications with 94.9% (avg) accuracy for data-serving applications and 93.5% (avg) accuracy for data-analytics applications.

# Performance VALIDATION ON system-A

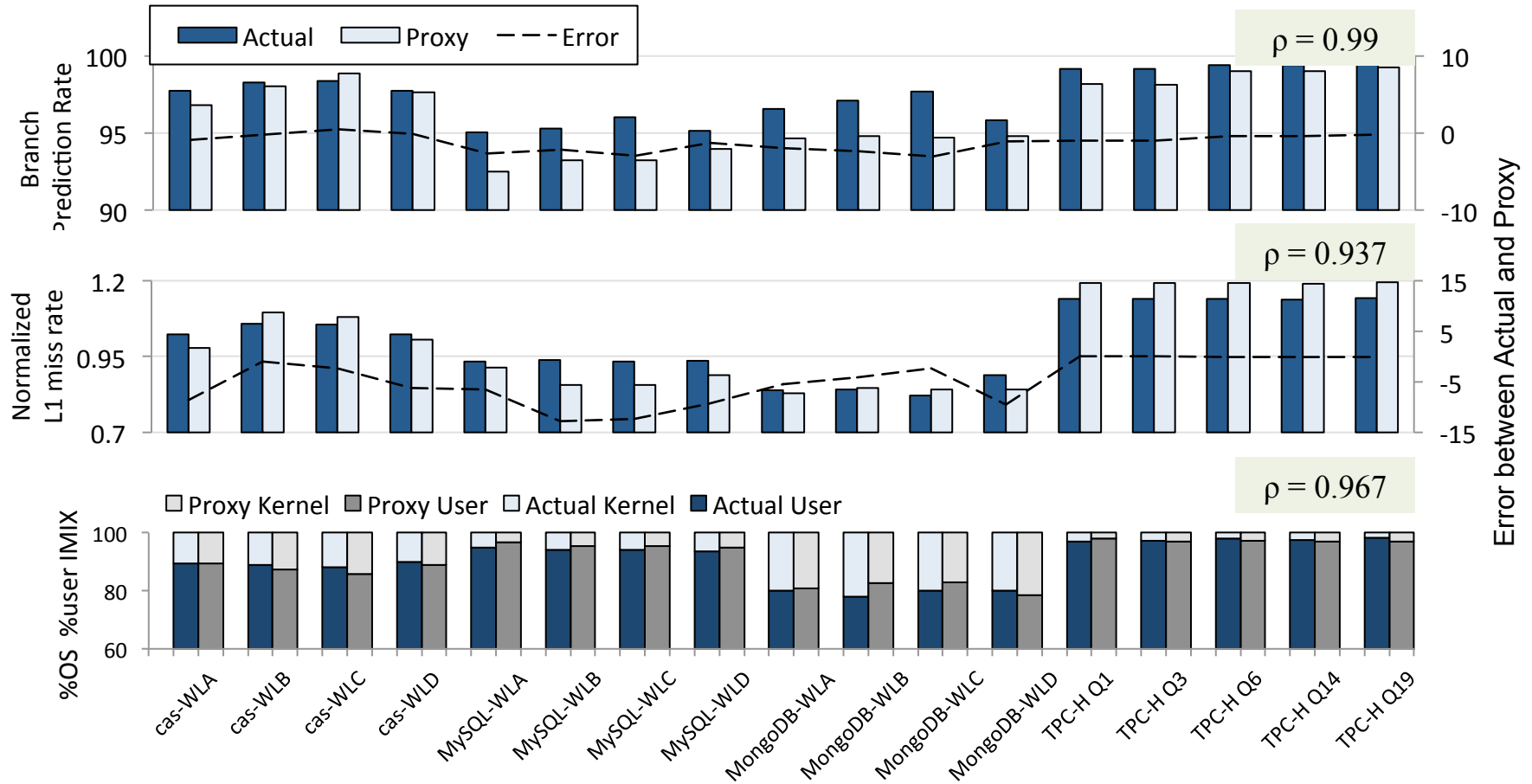

# POWER VALIDATION ON system-A

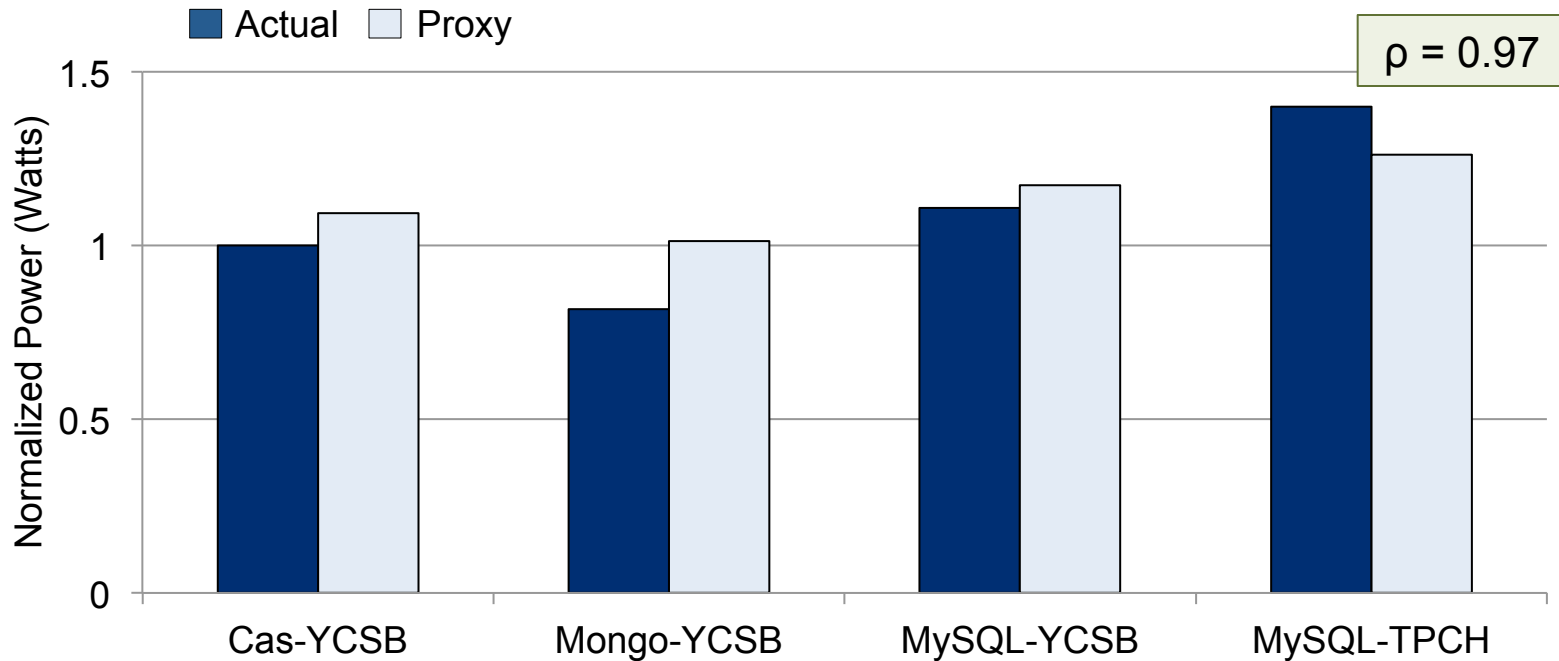

Correlation between the average power consumption of the proxy and actual applications is high (0.97).

# PERFORMANCE CROSS-VALIDATION ON system-B

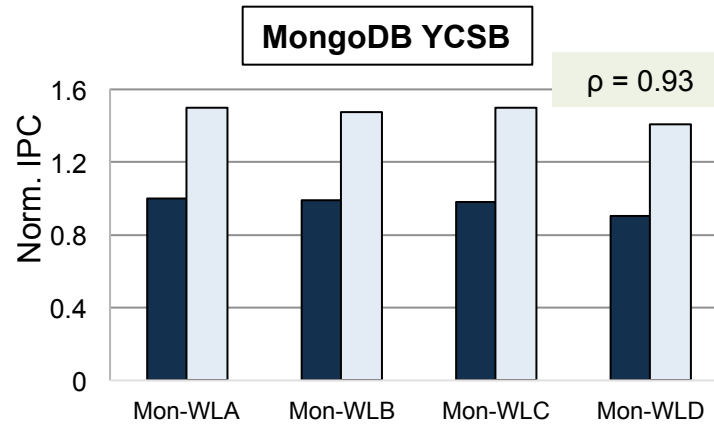
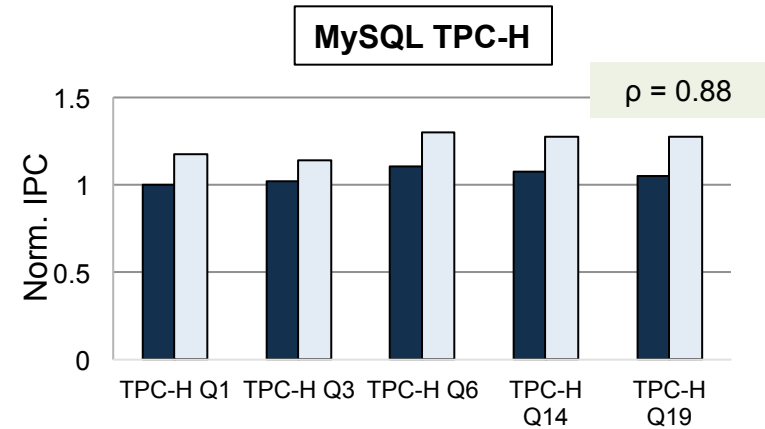
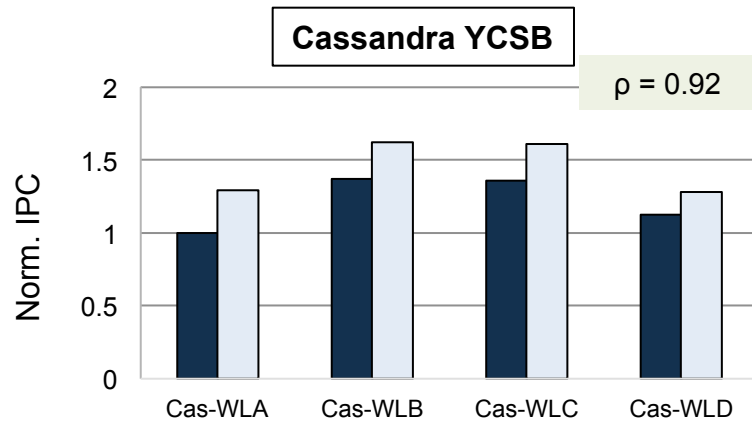

# SUMMARY OF ORIGINAL TO PROXY COMPARISON

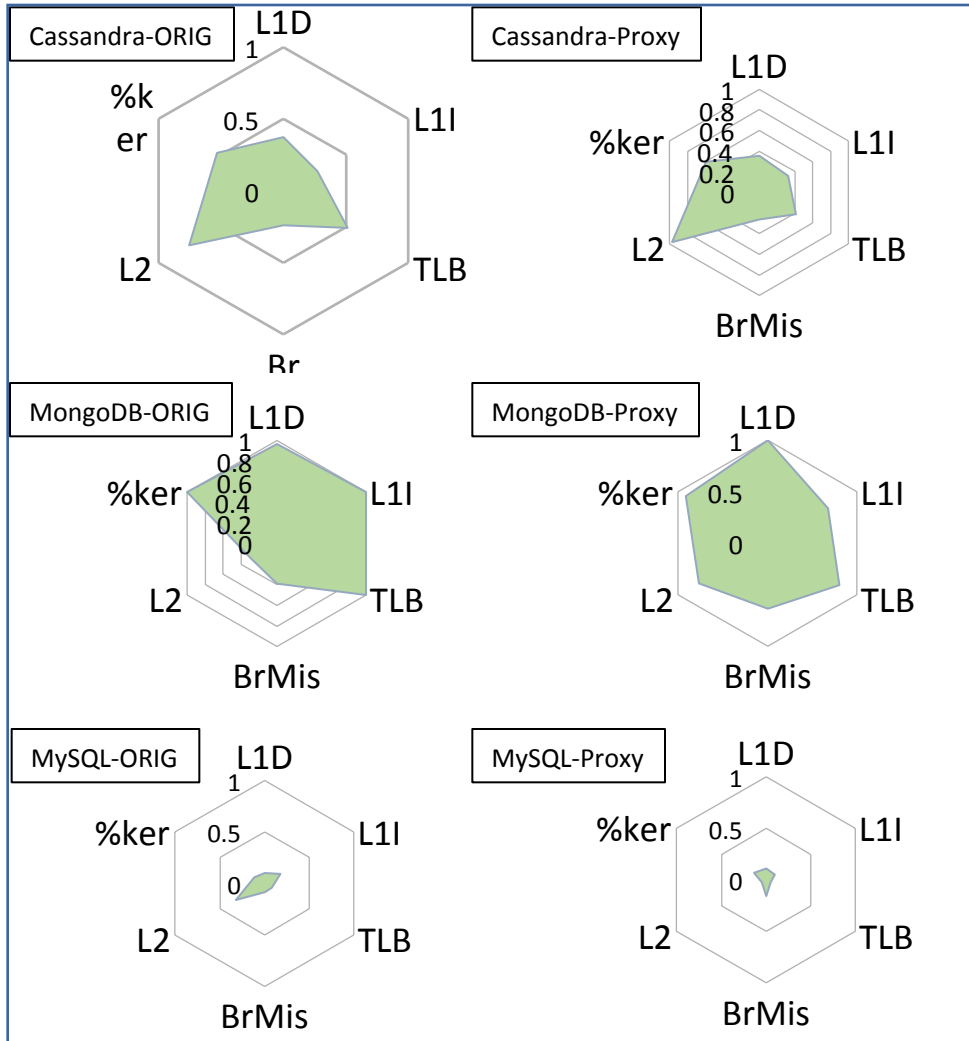



## Where to find proxies

- **Github repository with most up to date proxies:**  
<https://github.com/UT-LCA/Proxy-Benchmarks>
- **Proxies are all c programs that can be compiled with GCC**
  - Example: `gcc Deepsjeng.c -o Deepsjeng.o`
- **Performance counters can be gathered with perf or other tools**
  - Example: `perf Deepsjeng.o`

UT-LCA / Proxy-Benchmarks

Watch 2
Star 0
Fork 0

- [Code](#)
[Issues 0](#)
[Pull requests 0](#)
[Projects 0](#)
[Security](#)
[Insights](#)

Branch: master ▾ Proxy-Benchmarks / PROXIES /

[Create new file](#)
[Find file](#)
[History](#)

Cannot retrieve the latest commit at this time.

..

Big\_Data\_Benchmarks

CPU\_2017

UT-LCA / Proxy-Benchmarks











 Watch 2
  Star 0
  Fork 0

[Code](#)
[Issues 0](#)
[Pull requests 0](#)
[Projects 0](#)
[Security](#)
[Insights](#)

Branch: master ▾ Proxy-Benchmarks / PROXIES / Big\_Data\_Benchmarks /

[Create new file](#)
[Find file](#)
[History](#)

Cannot retrieve the latest commit at this time.

- ..
-  [proxy\\_cas\\_wc.c](#)
-  [proxy\\_cas\\_wc\\_sys.c](#)
-  [proxy\\_cas\\_wd.c](#)
-  [proxy\\_mongowa.c](#)
-  [proxy\\_mongowb.c](#)
-  [proxy\\_tpcq1.c](#)
-  [proxy\\_tpcq14.c](#)
-  [proxy\\_tpcq19.c](#)
-  [proxy\\_tpcq3.c](#)
-  [proxy\\_tpcq6.c](#)

UT-LCA / Proxy-Benchmarks

Watch 2 Star 0 Fork 0

Code Issues 0 Pull requests 0 Projects 0 Security Insights

Branch: master Proxy-Benchmarks / PROXIES / CPU\_2017 /

Create new file Find file History

Cannot retrieve the latest commit at this time.

- ..
- deepsjeng.c
- exchange2.c
- gcc.c
- leela.c
- mcf.c
- omnetpp.c
- perl.c
- x264.c
- xalancbmk.c
- xz.c

# SPEC'17 BENCHMARK OVERVIEW

- CPU2017 Benchmark Overview
  - 43 Benchmarks: Speed & Rate versions of INT and FP programs
- CPU2017 vs CPU2006 Runtime Comparison

Runtime Chars.	SPEC CPU2017	SPEC CPU2006
Average Inst. Count	7,876,399,266,409	1,896,452,771,834
Total run time (all benchmarks)	72, 299 seconds	9860 seconds

# Benchmark Characteristics

<b>Benchmark name</b>	<b>Language</b>	<b>KLoC</b>	<b>Application area</b>
<b>perlbench_s</b>	<b>C</b>	<b>362</b>	<b>Perl interpreter</b>
<b>Deepsjeng_s</b>	<b>C++</b>	<b>10</b>	<b>Artificial intelligence: alpha beta tree search (chess)</b>
<b>Omnetpp_s</b>	<b>C++</b>	<b>134</b>	<b>Discrete event simulation – computer network</b>
<b>Gcc_s</b>	<b>C</b>	<b>1304</b>	<b>GNU C compiler</b>
<b>Leela_s</b>	<b>C++</b>	<b>21</b>	<b>Artificial intelligence: Monte carlo tree search (Go)</b>

# Benchmark Characteristics

Benchmark name	Language	KLoC	Application area
xalanx_bmk_s	C++	520	XML to HTML conversion via XLST
mcf_s	C	3	Route Planning
x264_s	C	96	Video compression
exchange2_s	Fortran	1	Artificial Intelligence: recursive solution generator (Sudoku)
xz_s	C	33	General Data Compression

# Proxy Performance (IPC)

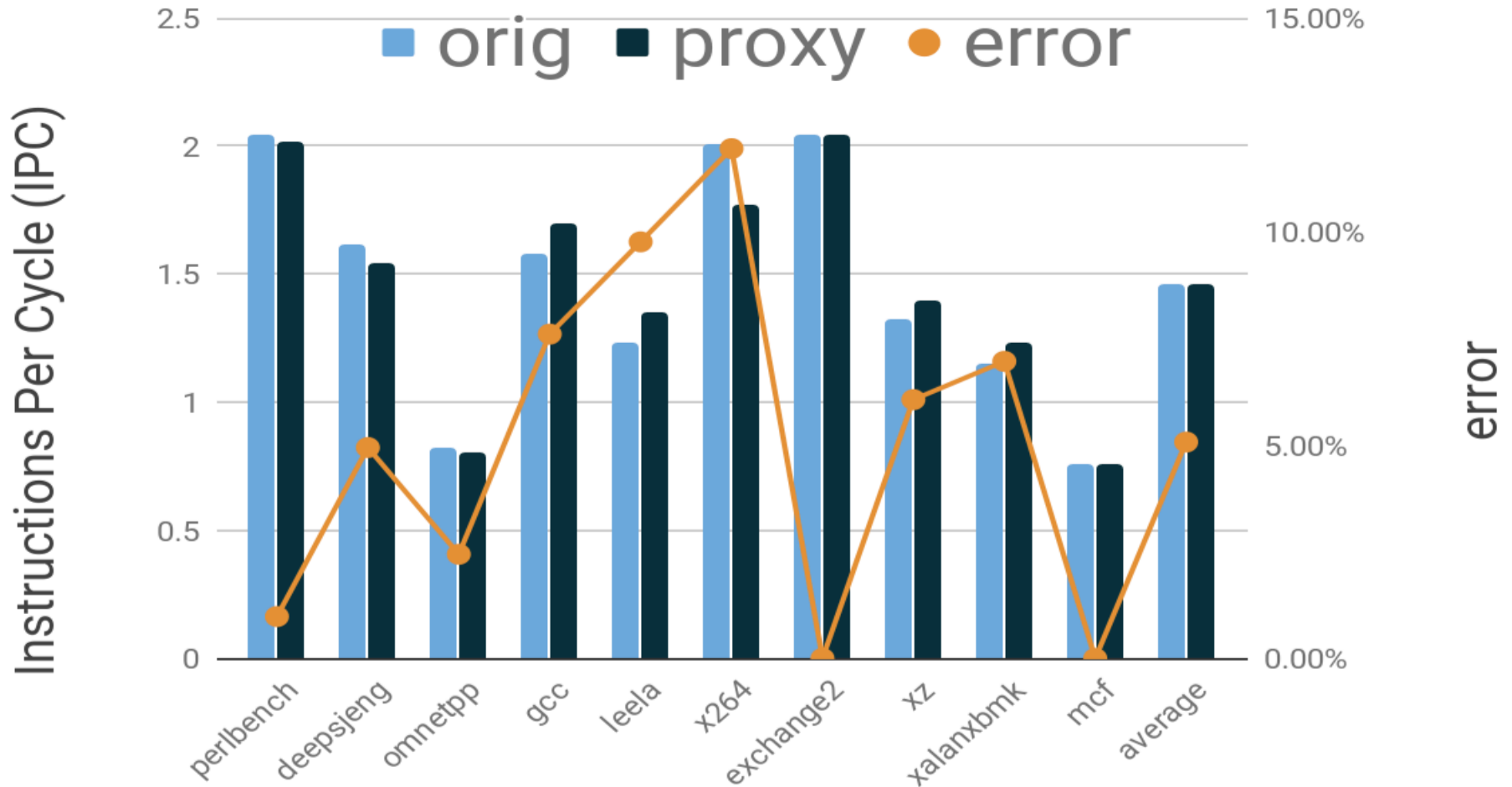



# Proxy Performance (Power)

Running Average Power Limit (RAPL)

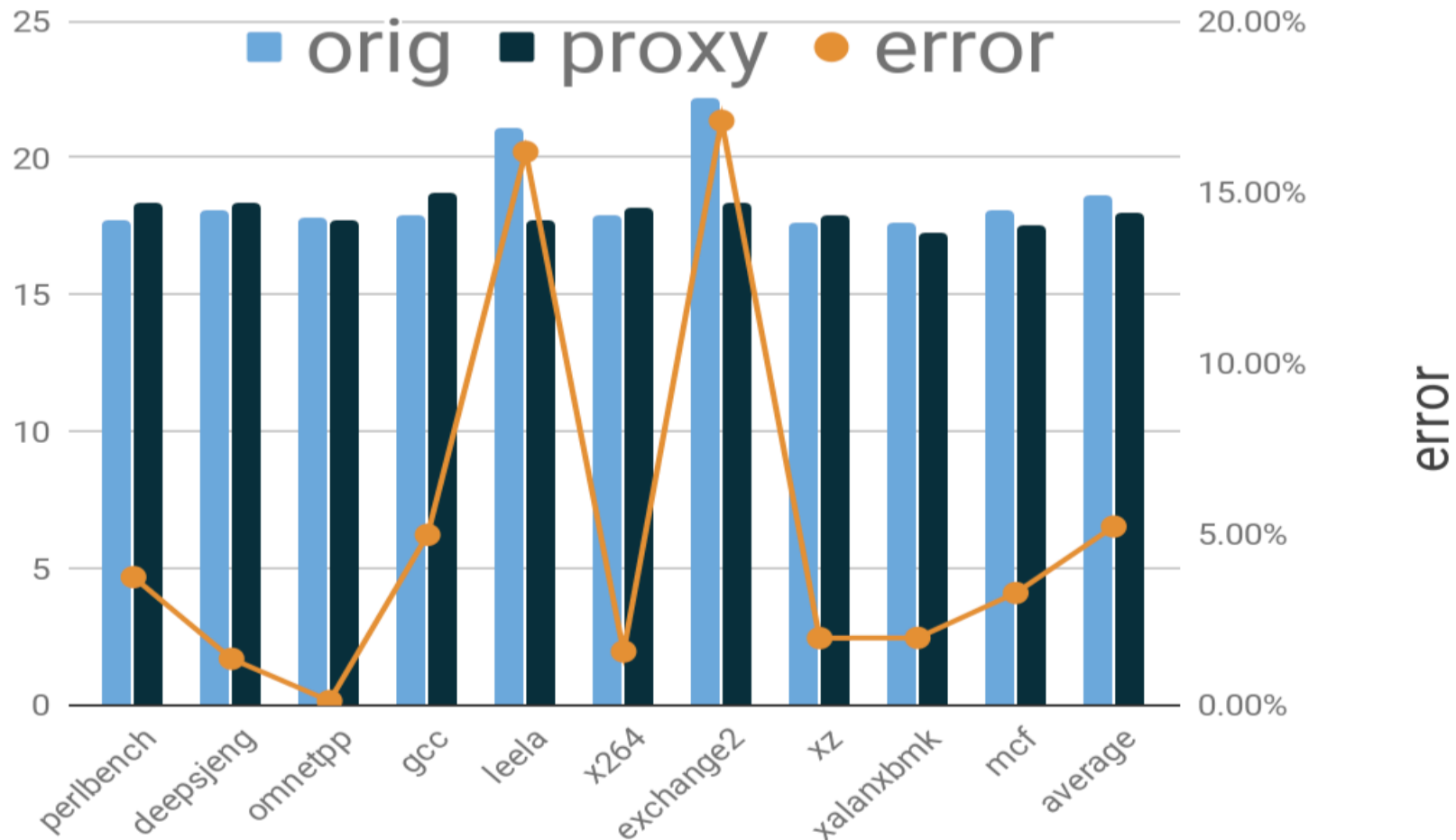

# Degree of Miniaturization

	perlbench		deepsjeng		omnetpp	
	Orig	Proxy	Orig	Proxy	Orig	Proxy
#Dyn Instructions	1,283,859,685,081	630,103,279	2,275,616,966,086	671,753,323	1,102,787,632,966	608,628,244
<b>Orig/Proxy # Instructions</b>	<b>2038</b>		<b>3388</b>		<b>1812</b>	

	gcc		leela			
	Orig	Proxy	Orig	Proxy		
#Dyn Instructions	4,577,230,000,000	982,597,009	2,245,850,995,706	423,060,220		
<b>Orig/Proxy # Instructions</b>	<b>4658</b>		<b>5309</b>			

- all proxies have less than 1 billion dynamic instruction count

# Degree of Miniaturization

	xalanxbmk		mcf		x264	
	Orig	Proxy	Orig	Proxy	Orig	Proxy
#Dyn Instructions	1,315,970,803,200	510,531,529	1,782,190,000,000	789,554,535	5030,000,000,000	809,326,203
<b>Orig/Proxy # Instructions</b>	<b>2578</b>		<b>2257</b>		<b>6219</b>	

	exchange2		xz			
	Orig	Proxy	Orig	Proxy		
#Dyn Instructions	6,643,720,000,000	895,456,832	5,030,530,000,000	818,316,812		
<b>Orig/Proxy # Instructions</b>	<b>7419</b>		<b>6147</b>			

- all proxies have less than 1 billion dynamic instruction count

# Control-flow Behavior

Comparing branch misprediction rate of ORIG and PROXY

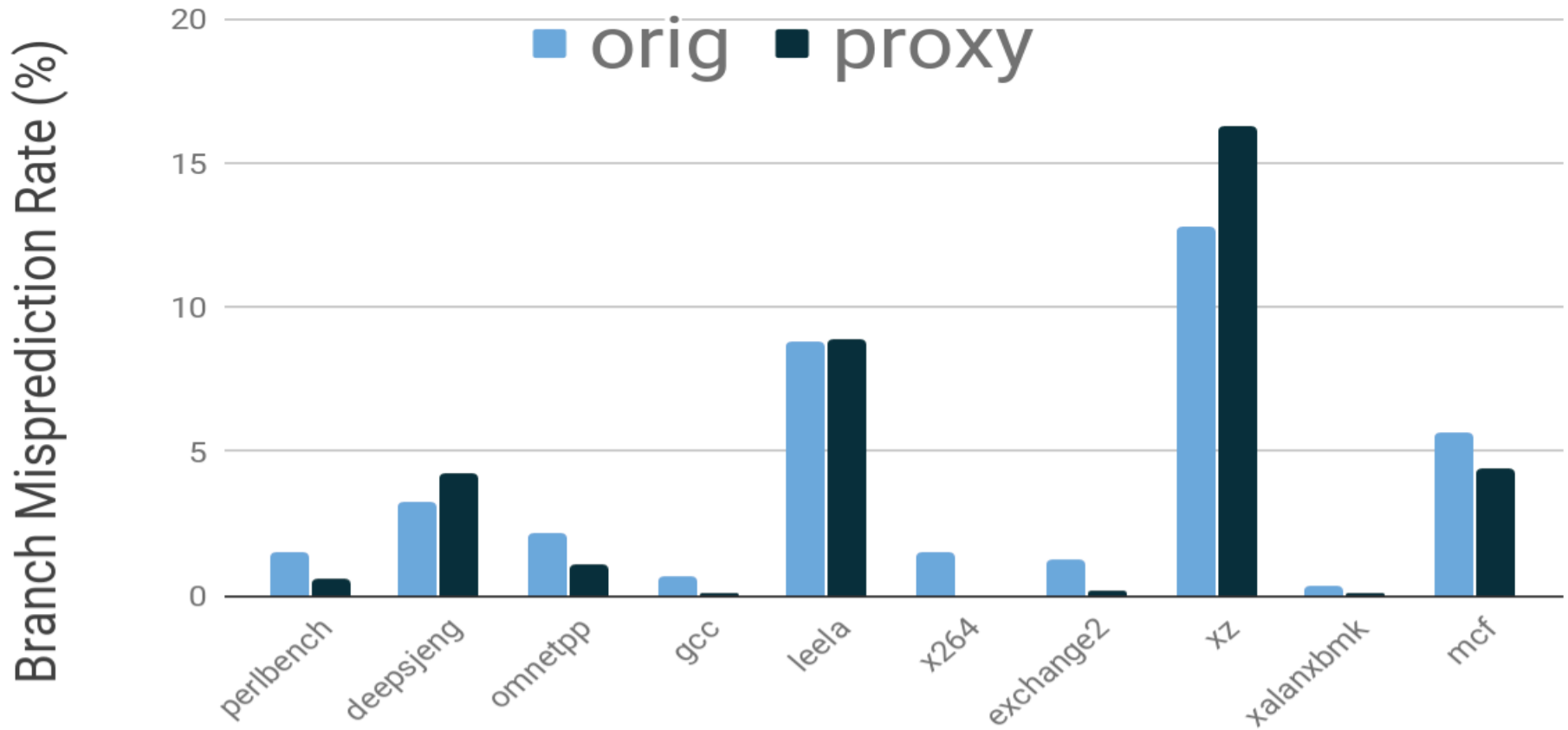

# Cache & TLB Performance (1/2)

	perlbench		deepsjeng		omnetpp		gcc		leela	
	ORIG	PROXY	ORIG	PROXY	ORIG	PROXY	ORIG	PROXY	ORIG	PROXY
DTLB MPKI	<b>0.10</b>	<b>0.01</b>	<b>0.22</b>	<b>0.01</b>	<b>5.00</b>	<b>0.09</b>	<b>0.34</b>	<b>0.02</b>	<b>0.04</b>	<b>0.02</b>
Dcache MPKI	<b>3.51</b>	<b>4.77</b>	<b>4.55</b>	<b>7.30</b>	<b>36.64</b>	<b>32.88</b>	<b>12.66</b>	<b>10.05</b>	<b>4.98</b>	<b>4.25</b>
L2 MPKI	<b>1.64</b>	<b>0.00</b>	<b>1.41</b>	<b>0.02</b>	<b>17.79</b>	<b>13.74</b>	<b>1.38</b>	<b>4.99</b>	<b>0.58</b>	<b>0.01</b>
L3 MPKI	<b>0.01</b>	<b>0.00</b>	<b>1.10</b>	<b>0.00</b>	<b>6.31</b>	<b>9.70</b>	<b>0.62</b>	<b>4.61</b>	<b>0.00</b>	<b>0.00</b>

# Cache & TLB Performance (2/2)

	X264		Exchange2		xz		xalanxbmk		mcf	
	ORIG	PROXY	ORIG	PROXY	ORIG	PROXY	ORIG	PROXY	ORIG	PROXY
DTLB MPKI	<b>0.03</b>	<b>0.01</b>	<b>0.00</b>	<b>0.02</b>	<b>2.04</b>	<b>0.00</b>	<b>2.89</b>	<b>0.02</b>	<b>1.48</b>	<b>0.05</b>
Dcache MPKI	<b>1.44</b>	<b>0.58</b>	<b>0.02</b>	<b>1.38</b>	<b>16.06</b>	<b>13.83</b>	<b>45.39</b>	<b>21.61</b>	<b>84.89</b>	<b>49.96</b>
L2 MPKI	<b>0.34</b>	<b>0.33</b>	<b>0.00</b>	<b>0.74</b>	<b>5.00</b>	<b>7.41</b>	<b>19.08</b>	<b>10.67</b>	<b>53.74</b>	<b>31.57</b>
L3 MPKI	<b>0.10</b>	<b>0.15</b>	<b>0.00</b>	<b>0.00</b>	<b>0.87</b>	<b>0.00</b>	<b>0.39</b>	<b>5.73</b>	<b>14.71</b>	<b>13.74</b>

# SimPoint as an Alternative – UT LCA SimPoints

- **SIMPOINTS** are popularly used with simulators to reduce simulation time.
- **UT Laboratory for Computer Architecture** has generated SimPoints for **SPEC CPU 2017**
- **SimPoints for SPEC CPU 2017** are available at <https://github.com/UT-LCA/Scalability-Phase-Simpoint-of-SPEC-CPU2017/releases>

Cannot retrieve the latest commit at this time.

..

README.md

README.md

## SimPoints

This folder holds the results of SimPoint study. Pinballs for SimPoints are available for download [here](#).

## Usage

Pinballs can be run natively using the Software Develop Emulator from Intel (<https://software.intel.com/en-us/articles/intel-software-development-emulator>). Gem5 (<http://gem5.org/Simpoints>) and Sniper (<http://snipersim.org/w/Pinballs>) also support the replaying of pinballs.

Interpreting the meaning of the 10 to 30 Pinballs for each workload in SPEC CPU 2017 is fairly straightforward. Each pinball base name specifies the key details for the pinball. An example is included below:

deepsjeng.test\_38307\_t0r1\_warmup1501\_prolog0\_region100000038\_epilog0\_001\_0-05045.0.address

The file has many parts to its name, each with a specific meaning.

"program name"."run name"\_"run number"\_t"thread number"r"region number"\_warmup"num warm up instructions"\_prolog"num prolog instructions"region"num instructions in region of interest"epilog"num epilog instructions""region number again"thread number again"- "weight of the region".0."file type"



# SimPoint as an Alternative

- Simpoint [1] breaks a workload into equal sized regions (100 Million Instructions)
- Regions are profiled based on micro-architecture independent Basic Block Vectors (BBV)
- Similar regions are clustered together based on the BBV using K-means
- A single region is simulated to represent each cluster

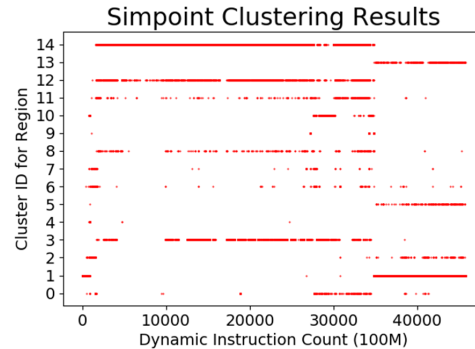
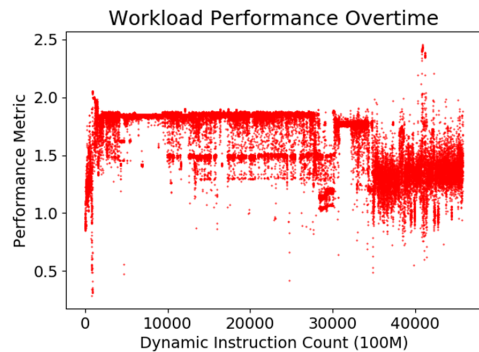

Cluster ID	Cluster Weight	Representative Perf. Metric
0	0.87%	1.60
1	23.62%	1.21
2	1.36%	1.91
3	12.00%	1.47
4	0.09%	1.04
5	0.44%	1.47
6	0.69%	1.61
7	0.36%	1.46
8	0.84%	1.54
9	0.17%	1.33
10	3.60%	1.16
11	0.82%	1.74
12	5.28%	1.77
13	1.21%	1.41
14	48.65%	1.85

Weighted Sum

Simpoint Estimate  
1.61

[1] Automatically Characterizing Large Scale Program Behavior:  
<https://dl.acm.org/citation.cfm?id=605403>

# SimPoint Limitations

- Dominant region can vary significantly from average behavior

Cluster ID	Cluster Weight	Representative Perf. Metric
0	0.87%	1.60
1	23.62%	1.21
2	1.36%	1.91
3	12.00%	1.47
4	0.09%	1.04
5	0.44%	1.47
6	0.69%	1.61
7	0.36%	1.46
8	0.84%	1.54
9	0.17%	1.33
10	3.60%	1.16
11	0.82%	1.74
12	5.28%	1.77
13	1.21%	1.41
14	48.65%	1.85



# SimPoints for CPU 2017

Benchmarks	Simulation Points	90 percentile Points	Instructions (billions)
<b>SPECSpeed Integer</b>			
600.perlbench_s	25	13	2696
602.gcc_s	15	5	7226
605.mcf_s	21	11	1775
620.omnetpp_s	8	5	1102
625.x264_s	14	9	12546
631.deepsjeng_s	20	16	2250
641.leela_s	29	21	2245
648.exchange2_s	19	15	6643
657.xz_s	21	15	8264
<b>Int Average</b>	<b>19.1</b>	<b>12.22</b>	<b>4607</b>
<b>SPECSpeed Floating-point</b>			
603.bwaves_s	9	3	66395
619.lbm_s	8	4	4416
638.imagick_s	15	6	66788
644.nab_s	12	5	13489
649.fotonik3d_s	17	7	4280
<b>FP Average</b>	<b>12.2</b>	<b>5</b>	<b>24204</b>

# Multiple SimPoints

Benchmarks	Start Instructions(100 million)/Weight(%)
600.perlbenc_s	(214681/28.85), (924424/12.60), (1277200/8.97), (1327590/7.96), (58779/7.77), (54633/5.43), (521547/5.39), (1233410/3.88), (752064/2.42), (701679/2.40), (789265/2.19), (1258340/2.06), (236975/1.78), (48882/1.71), (482810/1.44), (467463/0.77), (478321/0.68), (29698/0.68), (199580/0.61), (607466/0.55), (236842/0.54), (1339730/0.53), (1044350/0.30), (790578/0.30), (1141890/0.23)
602.gcc_s	(23077/48.65), (35817/23.62), (21069/12.00), (2812/5.28), (29282/3.60), (1353/1.36), (35911/1.21), (34118/0.87), (24369/0.84), (33794/0.82), (33733/0.69), (36933/0.44), (27933/0.36), (27185/0.17), (910/0.09)
605.mcf_s	(5943/21.24), (16201/12.54), (6315/10.82), (14440/10.75), (587/7.69), (6563/6.97), (13680/6.04), (7430/5.14), (14107/3.40), (12030/3.36), (12099/2.41), (9255/2.25), (7606/2.12), (14669/2.02), (7843/0.93), (15653/0.89), (12189/0.50), (17489/0.42), (9375/0.27), (15180/0.19), (1765/0.07)
620.omnetpp_s	(6053/32.56), (6737/30.32), (2966/15.25), (623/9.00), (1387/6.55), (9548/5.76), (10990/0.51), (10994/0.06)
625.x264_s	(49503/16.54), (22073/14.94), (3910/12.74), (42644/12.32), (10435/12.03), (46339/10.83), (26034/5.69), (41393/4.04), (11557/4.00), (24352/3.17), (4650/1.17), (11998/1.08), (53156/0.96), (31753/0.47)
631.deepsjeng_s	(17909/8.84), (21851/7.87), (84/7.02), (9700/7.00), (20151/6.98), (6204/6.37), (637/5.85), (7853/5.74), (20454/5.69), (15965/5.60), (14515/5.28), (9851/5.05), (3602/4.01), (12151/3.94), (5259/3.73), (11812/2.92), (11347/2.76), (3900/2.53), (15357/2.39), (0/0.46)
641.leela_s	(13198/8.63), (10150/7.15), (9272/6.85), (9870/6.75), (10635/6.57), (6871/5.64), (12252/5.49), (19208/4.29), (7341/4.17), (1830/3.90), (17685/3.67), (6004/3.59), (4934/3.45), (17328/3.37), (4952/3.10), (923/2.66), (21528/2.52), (1463/2.50), (22193/2.40), (1105/2.03), (820/1.91), (12296/1.84), (13929/1.60), (15764/1.47), (1193/1.36), (6041/1.15), (21296/0.98), (3514/0.96), (4/0.04)
648.exchange2_s	(41189/9.81), (46142/9.62), (28949/9.02), (32593/7.77), (46603/7.71), (11758/7.30), (50970/7.10), (27060/6.76), (3146/6.75), (66198/4.31), (38948/3.81), (17591/3.70), (31131/3.13), (20553/3.04), (9923/2.98), (56692/2.95), (424/1.68), (5824/1.63), (10190/0.95)
657.xz_s	(36567/13.00), (16895/9.39), (1400/8.92), (39442/8.76), (38731/6.97), (31742/6.59), (35941/6.33), (6913/5.80), (25357/5.25), (28962/4.09), (35764/3.86), (22587/3.21), (10870/3.02), (45973/2.94), (29995/2.88), (39598/2.72), (45675/2.26), (40484/2.04), (38264/1.88), (18/0.07), (44672/0.02)
603.bwaves_s	(59291/71.46), (248007/14.61), (287430/5.89), (313019/3.23), (315053/2.21), (95707/1.67), (318138/0.34), (263763/0.31), (303136/0.28)
619.ibm_s	(7134/69.69), (10742/14.92), (43825/4.43), (11740/4.36), (6240/3.65), (9400/2.38), (8491/0.56), (0/0.01)
638.imagick_s	(551856/43.83), (394592/27.24), (467091/8.12), (28460/4.97), (91452/4.24), (4209/2.76), (41027/2.50), (515828/2.45), (72623/1.27), (656007/1.21), (651005/0.78), (10504/0.54), (102890/0.04), (272722/0.04), (567401/0.04)
644.nab_s	(9237/34.24), (52046/22.75), (56855/17.91), (58776/9.76), (122599/7.45), (133757/6.91), (48950/0.26), (120710/0.25), (130263/0.16), (104620/0.14), (76009/0.09), (84205/0.08)
649.fotonik3d_s	(19088/43.91), (2468/29.02), (56395/6.90), (1608/4.72), (11626/2.65), (53620/2.21), (17985/2.12), (33097/1.95), (35644/1.20), (38568/0.91), (31846/0.83), (44869/0.83), (3563/0.80), (46262/0.64), (33943/0.49), (43842/0.41), (36949/0.41)

# How to read the Table of Multiple SimPoints

600.perlbench_s	(214681/28.85), (924424/12.60), (789265/2.19), (1258340/2.06), (236842/0.54), (1339730/0.53),
602.gcc_s	(23077/48.65), (35817/23.62), (27113/11.75), (36933/0.44), (27933/0.36), (27113/0.36)
605.mcf_s	(5943/21.24), (16201/12.54), (6309/6.75), (9255/2.25), (7606/2.12), (14669/3.61)

In many cases, the dominant SimPoint has less than 10% weight

631.deepsjeng_s	(17909/8.84), (21851/7.87), (84/7.02), (9700/7.00), (20151/6.98), (623602/4.01), (12151/3.94), (5259/3.73), (11812/2.92), (11347/2.76), (1193/1.36), (6041/1.15), (21296/0.98), (3514/0.96), (40.04)
641.leela_s	(13198/8.63), (10150/7.15), (9272/6.85), (9870/6.75), (10635/6.57), (4934/3.45), (17328/3.37), (4952/3.10), (923/2.66), (21528/2.52), (141193/1.36), (6041/1.15), (21296/0.98), (3514/0.96), (40.04)
648.exchange2_s	(41189/9.81), (46142/9.62), (28949/9.02), (32593/7.77), (46603/7.71), (17591/3.70), (31131/3.13), (20553/3.04), (9923/2.98), (56692/2.95),

Proxies allow us to make a single proxy for the whole benchmark

Or

One proxy per SimPoint,

giving more accuracy than the dominant SimPoint

# Industry Use

IBM – 2006

AMD – 2010

Intel 2017-2019

## Miniature Benchmarks for RTL Model Validations

- **“Automatic Testcase Synthesis and Performance Model Validation for High Performance PowerPC Processors”, Bell, Bhatia, John, Stuecheli, Griswell, Tu, Capps, Blanchard, and Thai, IEEE International Symposium on Performance Analysis of Systems and Software (ISPASS). March 2006.**



# Presentation by EMILY SHRIVER, Intel

# Improving Accuracy of Proxies

- **Current Challenges**
  - **Major Inaccuracies**
  - **Branch Behavior Capture**
  - **Memory Behavior Capture**

# Improving Branch Behavior

- **Branch Profiling has become more precise in order to increase accuracy**
- **Initially Global Transition Rate [1]**
- **Added Global Taken Rate**
- **Added Per Branch (local) Transition and Taken Rate**
- **Added inter Branch Correlation [2]**
- **Adding Variable inter Branch Correlation**

[1] M. Haungs, P. Sallee, et al "Branch transition rate: a new metric for improved branch classification analysis," [HPCA2000]

[2] Pan, Shien-Tai, Kimming So, et al "Improving the accuracy of dynamic branch prediction using branch correlation." [ACM1992]

# Proxy Branch Generation – Overview

- **Branch mispredictions reduce overall IPC**
  - Speculative work must be discarded
- **Proxies should have branch predictor performance similar to original**
- **Metric of Interest: MPKI**
  - Misses per thousand branch instructions

# Profiling Branch Behavior

- **Profile local behavior, i.e. per-static-branch**
- **Maintain a data structure for each static branch in the workload**
- **Every time a branch is encountered:**
  - Increment the “encountered” count for the branch
  - If taken: increment the “taken” count for the branch
  - Compare taken behavior with the last time it was encountered
    - If different: increment the “transition” count for the branch
- **Write raw results to file**
- **Discard data from extremely rare branches**
  - 10% of static branches can make up 99.99% of dynamic branches

# Proxy Branch Generation

- **Use original static branches as “templates” for proxy branches**
  - Each proxy branch matches the taken and transition rates of its template
  
- **How many branches should use each template?**
  - Each proxy branch is dynamically executed the same number of times
  - Particularly common original branches should be used for multiple proxy branches
  - Scaling step automatically performed

# Limitations of Existing Branch Model

- **High degree of randomness in branches**
  - Makes prediction harder, resulting in too-high MPKI for some workloads
- **Disabling randomization has the opposite problem**
  - MPKI too low for some workloads
- **What's causing this?**
  - Modern branch predictors examine interbranch relations
    - Branch history registers
  - Proxy branch generator only looks at branches individually

## Improving Memory Access Patterns

- **The proxies in the repository use a stride based memory model that captures a per instruction memory pattern**
  - Example: a load instruction accesses x3000, then x3008, x3010, x3018, ....
- **Recent research (HALO) has found better accuracy through modeling[1]:**
  - Intra-region stride locality
  - Inter-region reuse locality
- **Currently developing proxies that implements these two techniques into the proxy**

[1] Panda, Reena, and Lizy K. John. "HALO: A Hierarchical Memory Access Locality Modeling Technique For Memory System Explorations." In Proceedings of the 2018 International Conference on Supercomputing, pp. 118-128. ACM, 2018.



# HALO Memory Behavior

- **For intra-region locality, a Markov chain is created for each region of memory to track patterns within**
- **The probability of switching between regions is calculated for the inter-region reuse locality**
- **HALO combines the intra-region locality and inter-region reuse distance to create similar memory traces**

# HALO Memory Behavior

- **Focuses on two key components**

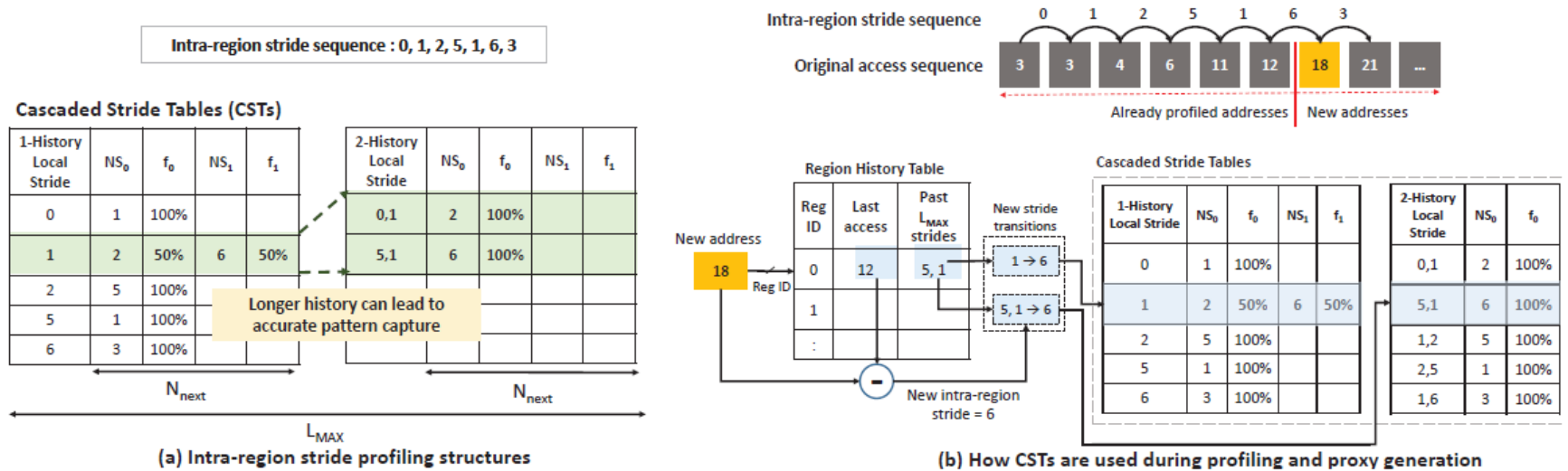

Figure 4: Intra-region locality profiling using cascaded stride tables (CSTs).

## Reproducibility

---

- Reproducibility of Research using Proxies
  - Miniaturization Standpoint
  - Software Stack Abstraction Standpoint
  - Proprietary Codes Standpoint
  - Simulator Validation Standpoint
- Would like the research community to use the proxies along with other benchmarks
  - SPEC CPU 2017 Proxies
  - Data base (Cassandra, MongoDB, MySQL) Proxies
  - Github

# ISA Independent Synthetic Benchmark Generation

- **Step 1: Generate synthetic code in LLVM IR**
  - Use Static Single Assigned (SSA) form
  - Not bounded to specific ISA
  - Targeting total number of dynamic instructions to desired value
- **Step 2: Create assembly for target ISAs**
  - Use modified LLVM backend
  - Disable optimization paths to preserve characteristics
- **Step 3: Compile binary for target ISAs**
  - Use general compiler for each ISAs
  - Does not require specialized tools

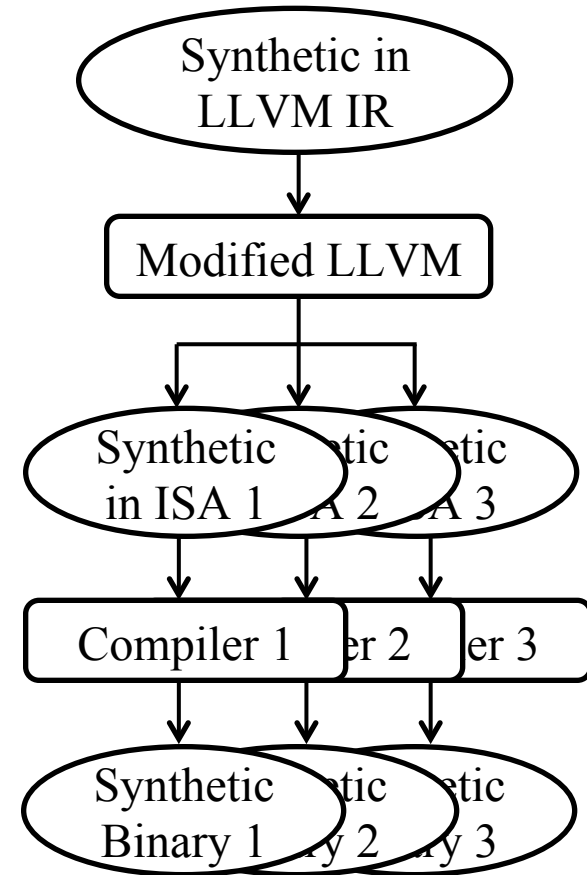

# ISA Independent Synthetic Benchmarks

- **LLVM compiler infrastructure**
  - A virtual instruction set language
  - Various back-end support – x86, PowerPC, ARM, Alpha, SPARC, etc.
- **Use virtual ISA in SSA form**
  - Micro architecture independent
  - Avoid machine-specific optimizations in the front-end
  - Back-end takes care of machine-dependent optimizations

```

#include <stdio.h>

int main()
{
    int i;
    int q,r,t, x[100000], y[100010], z[100011];

    for (i=0;i<100000;i=i+1)
    {
        x[i]= q + y[i]*(r*z[i+10] + t *z[i+11]);
        printf("%d\n",x[i]);
    }

    return 0;
}

```

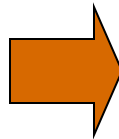

```

%tmp1 = load i32* %i, align 4
%tmp2 = load i32* %i, align 4
%tmp3 = getelementptr [100010 x i32]* %y, i32 0, i32 %tmp2
%tmp4 = load i32* %tmp3, align 4
%tmp5 = load i32* %i, align 4
%tmp6 = add i32 %tmp5, 10
%tmp7 = getelementptr [100011 x i32]* %z, i32 0, i32 %tmp6
%tmp8 = load i32* %tmp7, align 4
%tmp9 = load i32* %r, align 4
%tmp10 = mul i32 %tmp8, %tmp9
%tmp11 = load i32* %i, align 4
%tmp12 = add i32 %tmp11, 11
%tmp13 = getelementptr [100011 x i32]* %z, i32 0, i32 %tmp12
%tmp14 = load i32* %tmp13, align 4
%tmp15 = load i32* %t, align 4
%tmp16 = mul i32 %tmp14, %tmp15
%tmp17 = add i32 %tmp10, %tmp16
%tmp18 = mul i32 %tmp4, %tmp17
%tmp19 = load i32* %q, align 4
%tmp20 = add i32 %tmp18, %tmp19

```

# ISA Independent Synthetic Benchmarks

LLVM ISA

```

%tmp1 = load i32* %i, align 4
%tmp2 = load i32* %i, align 4
%tmp3 = getelementptr [100010 x i32]* %y, i32 0, i32 %tmp2
%tmp4 = load i32* %tmp3, align 4
%tmp5 = load i32* %i, align 4
%tmp6 = add i32 %tmp5, 10
%tmp7 = getelementptr [100011 x i32]* %z, i32 0, i32 %tmp6
%tmp8 = load i32* %tmp7, align 4
%tmp9 = load i32* %r, align 4
%tmp10 = mul i32 %tmp8, %tmp9
%tmp11 = load i32* %i, align 4
%tmp12 = add i32 %tmp11, 11
%tmp13 = getelementptr [100011 x i32]* %z, i32 0, i32 %tmp12
%tmp14 = load i32* %tmp13, align 4
%tmp15 = load i32* %t, align 4
%tmp16 = mul i32 %tmp14, %tmp15
%tmp17 = add i32 %tmp10, %tmp16
%tmp18 = mul i32 %tmp4, %tmp17
%tmp19 = load i32* %q, align 4
%tmp20 = add i32 %tmp18, %tmp19
    
```

ISA	Static Code Size	Inst. Count	Cycle Count	IPC
x86	45 (18)	80.7M	68.2M	1.18
Sparc	93 (55)	50.8M	47.2M	1.08
Alpha	100(44)	107.4M	72.4M	1.48

Alpha

Sparc

x86

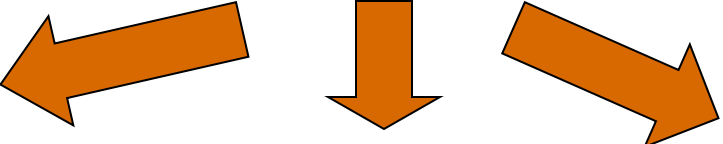

```

s4addq $0, $3, $3
mulq $1, $4, $1
mulq $2, $5, $2
lda $4, 20($30)
ldl $3, 0($3)
addq $2, $1, $1
ldl $2, 0($4)
mulq $3, $1, $1
lda $3, 32($30)
addq $1, $2, $1
s4addq $0, $3, $0
stl $1, 0($0)
ldl $0, 0($11)
s4addq $0, $3, $0
    
```

```

sethi 4193522, %g1
add %g1, %i6, %g1
add %g1, 680, %i5
smul %i11, %i14, %i11
smul %i12, %i13, %i12
ld [%i15+%i10], %i13
add %i12, %i11, %i11
sethi 4193132, %g1
add %g1, %i6, %g1
ld [%g1+28], %i12
smul %i13, %i11, %i11
sethi 4193132, %g1
add %g1, %i6, %g1
add %g1, 40, %i13
add %i11, %i12, %i11
st %i11, [%i13+%i10]
sethi 4193132, %g1
add %g1, %i14, %g1
    
```

```

movl 12(%esp), %eax
movl 800112(%esp,%eax,4), %ecx
imull 24(%esp), %ecx
movl 800108(%esp,%eax,4), %edx
imull 20(%esp), %edx
addl %ecx, %edx
    
```

# Other Applications

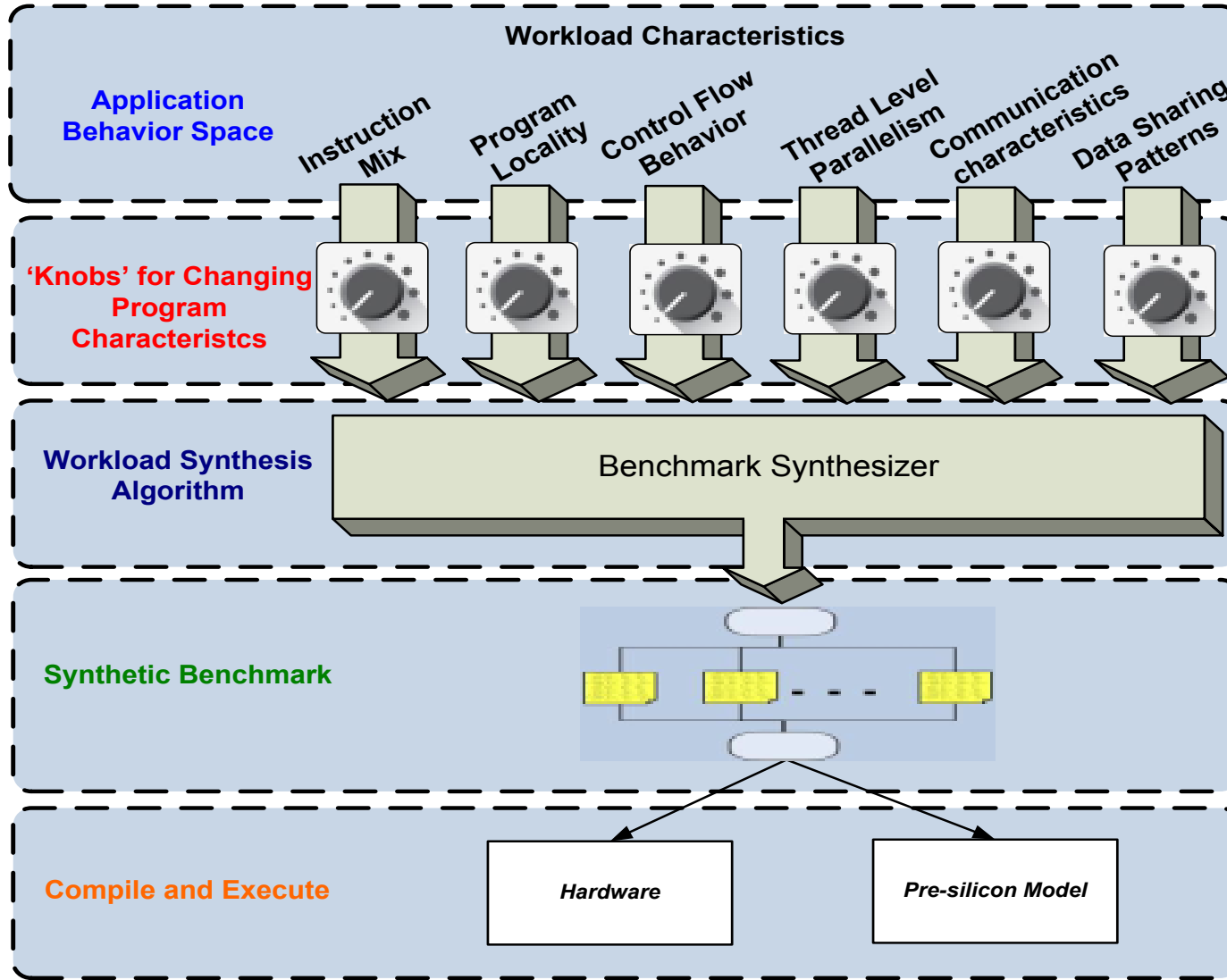

- Generate Clones by setting knobs to appropriate values
- Adaptable
- Scalable
- Futuristic

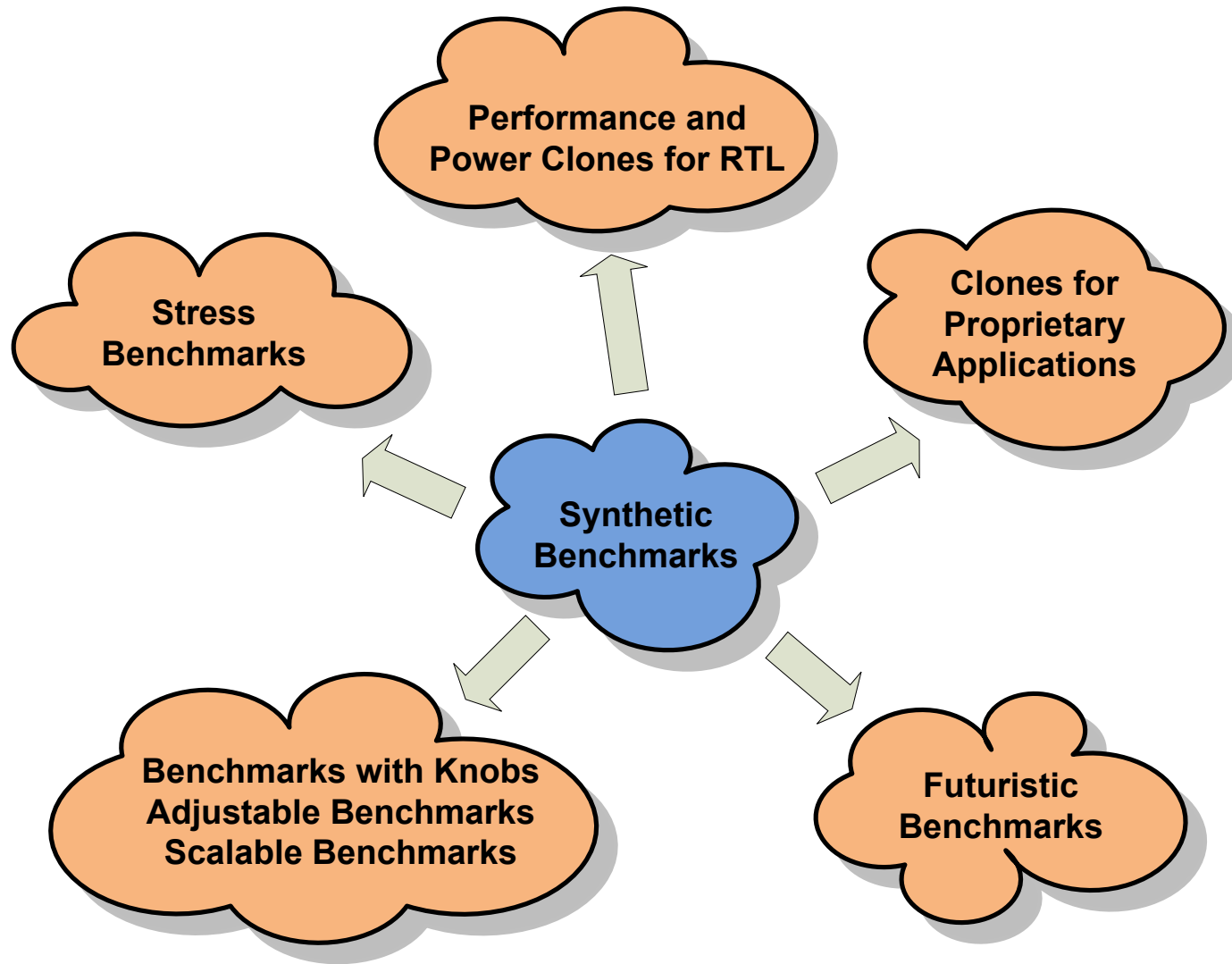



# Sharing Proprietary Applications

- Military Applications cannot be shared with Vendors
- Many commercial applications cannot be shared freely between software and hardware developers

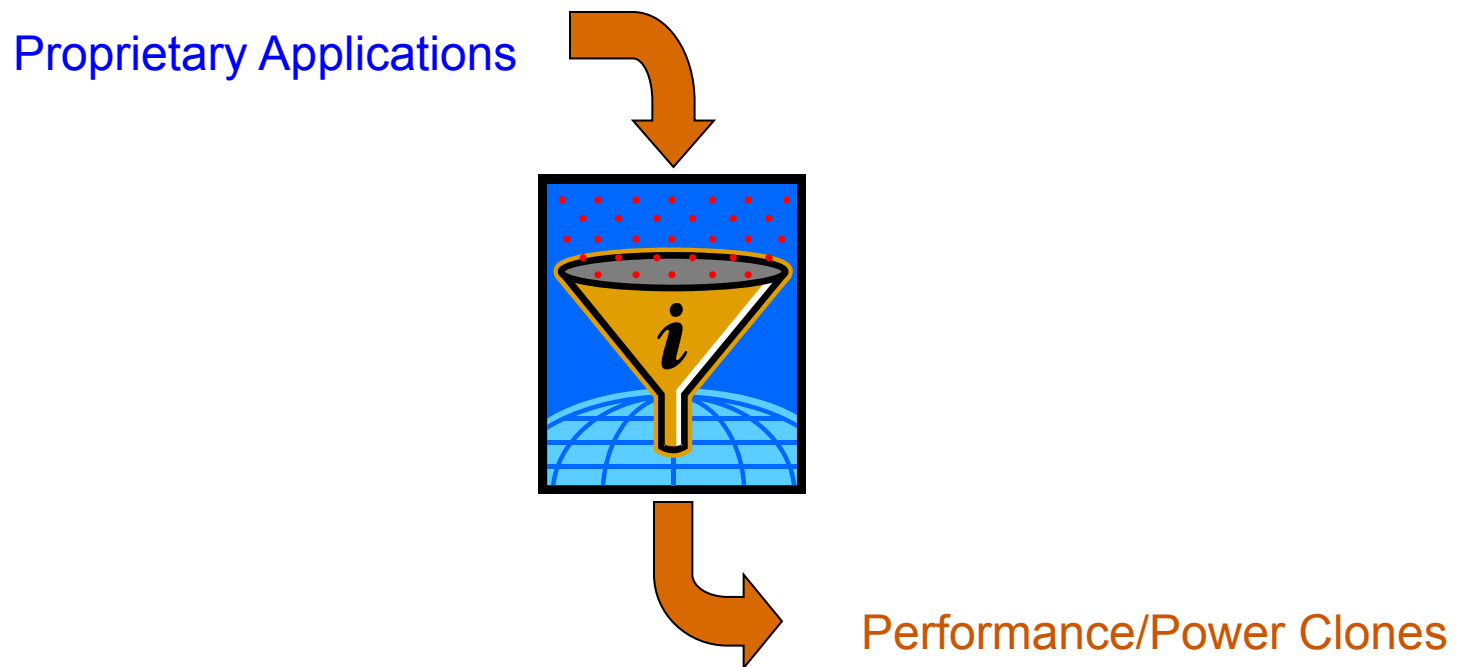

## Early Performance Testing

- **Usage Scenario**
    - Derive proxy applications from a set of workload characterizations
    - Proxies convey no proprietary information, but capture the execution behavior of XX's applications
    - Proxy applications can be available very early in project
    - Proxies focus on the computationally significant portions of code, not the small parts that are hardware-dependent (e.g., DMA, etc.)
- *Early testing confirms performance, or discovers shortfalls in time to address them before final integration*

*Platform-independent  
Workload  
Characterizations*

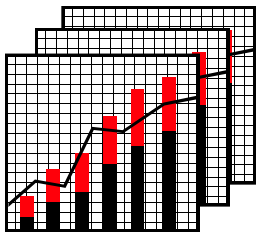

*Platform Performance  
Prediction & Analysis  
Engine*

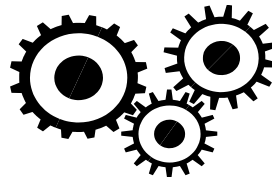

*Workload-Derived  
Application Proxies*

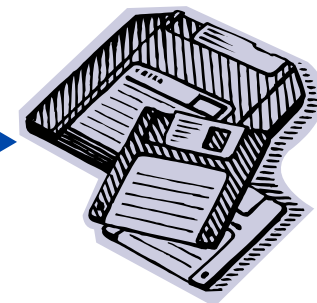

# Proxy Applications can Transform Procurement Process

- **Proxy applications can turn vendors into partners in achieving performance goals**
  - Provides them with means to directly measure performance
  - Places the iterative test/analyze process in vendor's lab
  - Reveals no proprietary information
  
- **Turn hardware performance tuning into a supplier task**
  - Periodically capture application performance in a new set of proxies
  - Task supplier to re-tune hardware for best performance as applications mature



# POWER AND THERMAL STRESSMARKS

- **Hand crafting code snippets for power viruses**
  - Very tedious process, complex interactions inside the processor
  - Cannot be sure if it is the maximum case
  - Heavily architecture dependent; heavy domain knowledge
- **We automatically generate power viruses**

Power Virus	Optimized to stress	Language
MPrime	All CPUs, all ISAs	C
CPUburn-in	X86 machines	x86 assembly
BurnP5	Intel Pentium w&w/o MMX processors	x86 assembly
BurnP6	Intel PentiumPro, Pentium II, Pentium III and Celeron CPUs	x86 assembly
BurnK6	AMD K6 processors	x86 assembly
BurnK7	AMD Athlon/Duron processors	x86 assembly
BurnMMX	cache/memory interfaces on all CPUs with MMX	x86 assembly

# POWER and THERMAL STRESSMARKS

- Automatically search for power viruses using an abstract workload model and machine learning

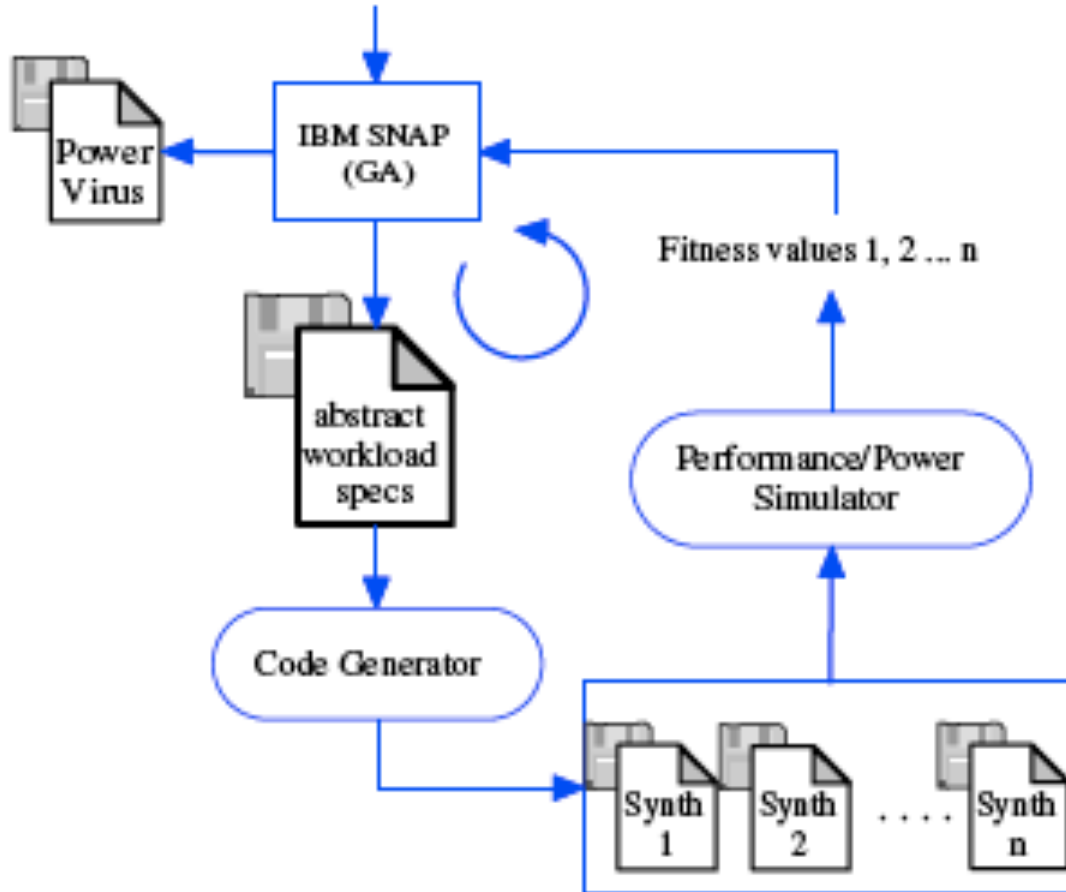

- GA: search heuristic to solve optimization problems**
- Choose a random population, evaluate fitness, apply GA operators to generate next population
- Evolve until required fitness achieved

# Power measurement of Viruses on Hardware

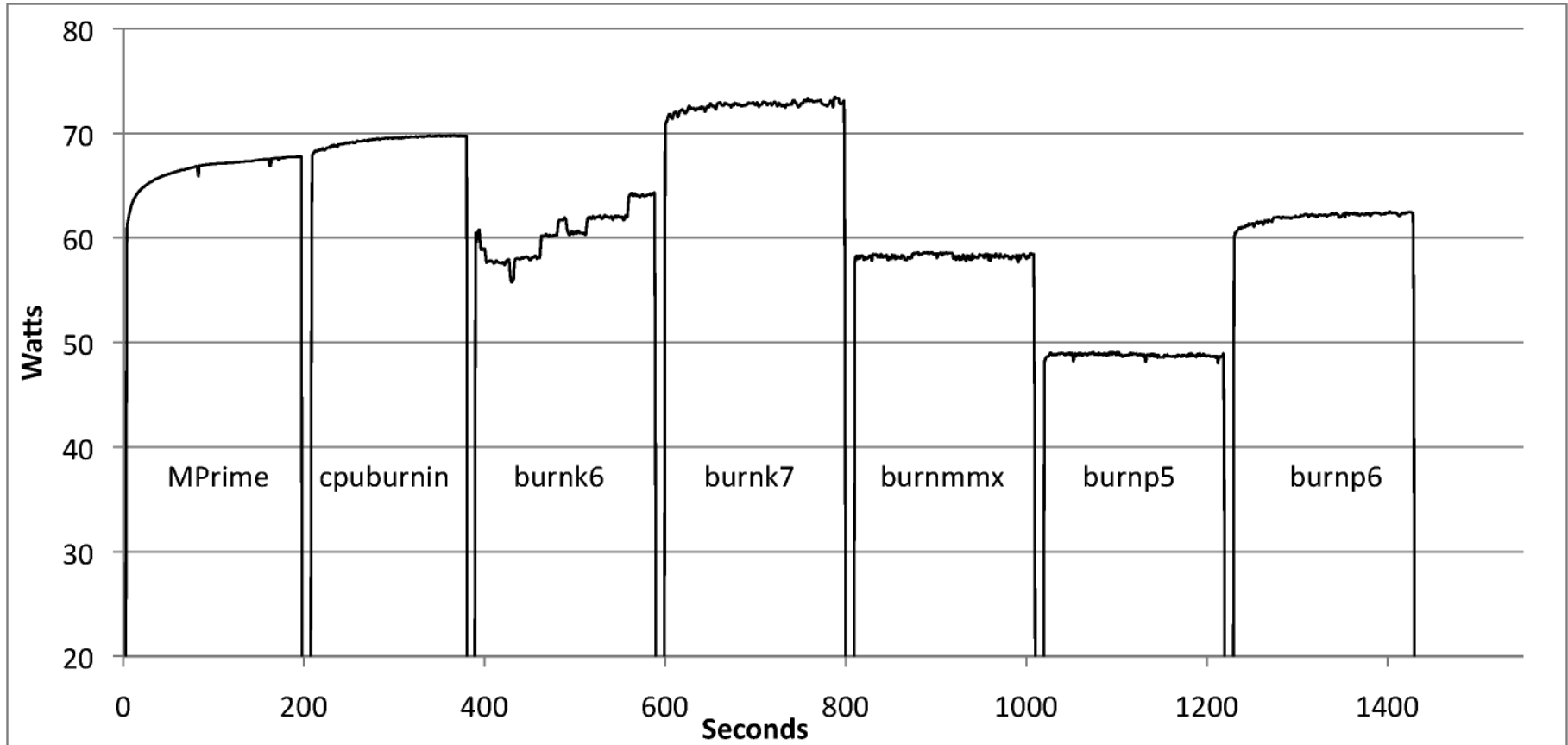

- **BurnK7 – 72.1 Watts**
- **SPEC CPU2006: 416.gamess and 453.povray consume highest power of 63.1 and 59.6 Watts**

# SYMPO Framework – Genetic Algorithm

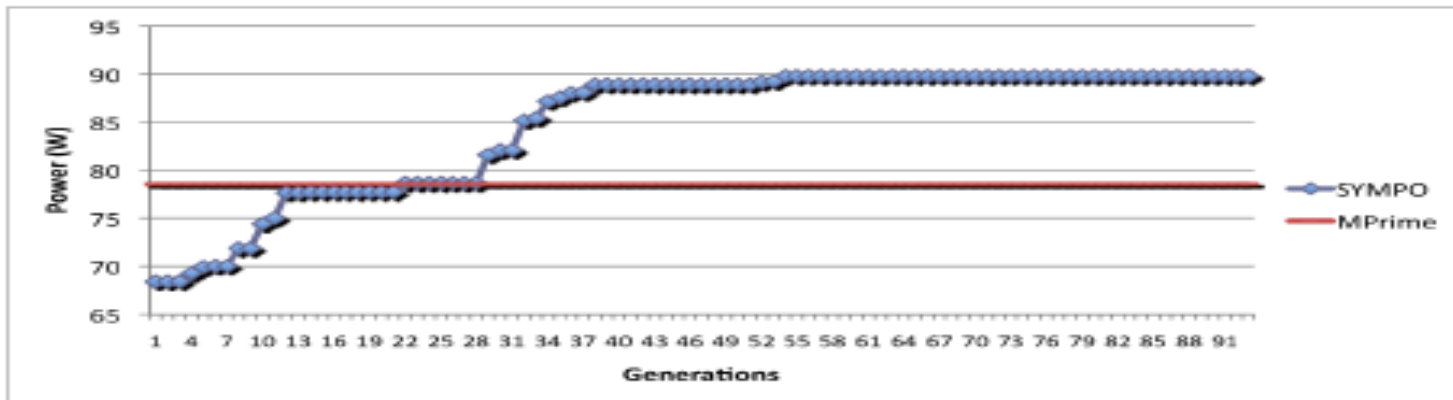
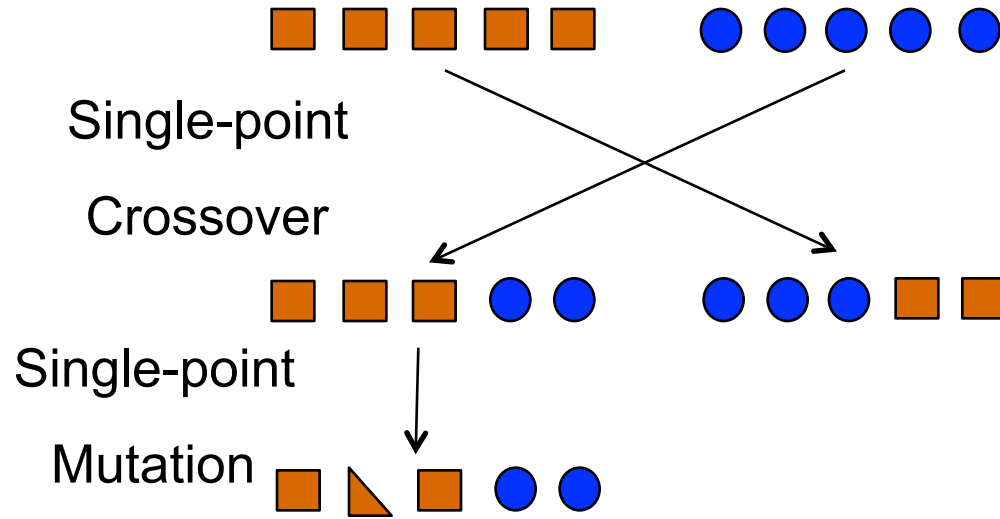

# Validation on Real Hardware

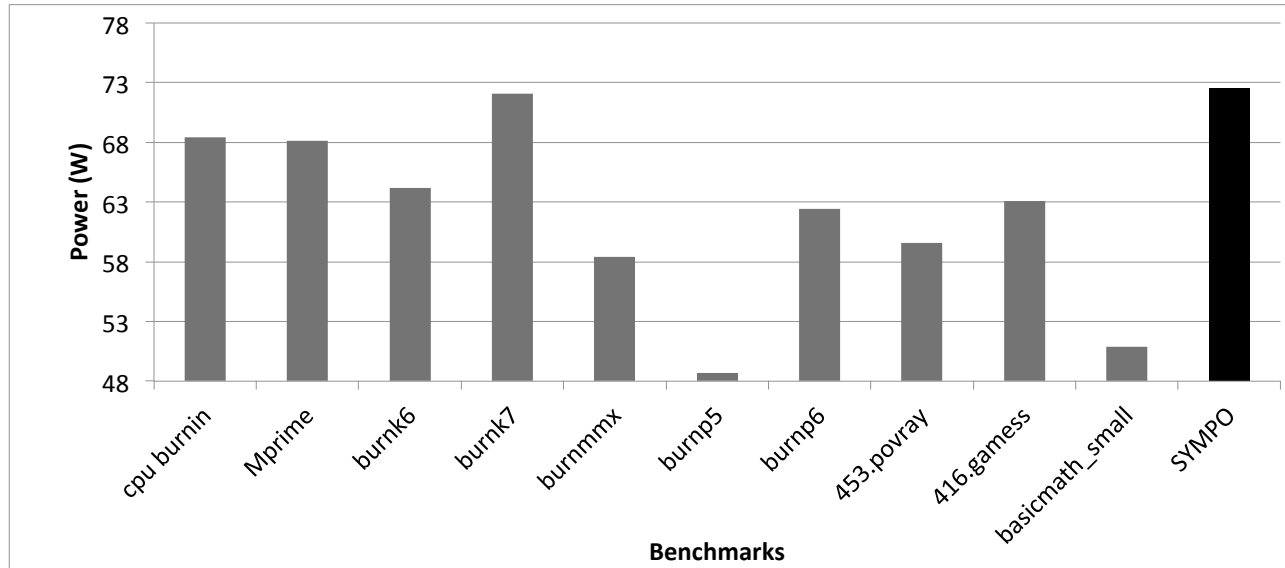

- **Our code generator was not equipped to generate code for x86 at that time**
  - Generated power viruses on SPARC ISA and translated to x86 using LLVM infrastructure



# A Solution to The Expiring Benchmark Problem

- SPEC89, SPEC92, SPEC95, SPEC CPU2000, CPU 2006
- TPC A, TPC B, TPC D
- Benchmarks become obsolete very quickly
- Benchmark makers create inflated data sets to stay alive at least 4-5 years
- Generate futuristic benchmarks using the proxy code generator



# Interactive Workloads??

High-level feature categories need to be modified for interactive properties

- |   |                                      |
|---|--------------------------------------|
| 1 | Instruction-level Characteristics    |
| 2 | Control-flow Characteristics         |
| 3 | Memory-access Characteristics        |
| 4 | Interactive Workload Characteristics |

# Weaknesses – The Vitamin Tablet Problem



Vitamin A, B, C, D, E, K



What about undiscovered vitamins? Vitamin P, Q, R?

# Conclusion

- We have developed a proxy generation methodology to generate miniature proxy benchmarks.
- PerfProx proxies can enable fast and efficient performance evaluation of emerging workloads without needing back-end database or complex software stack support.
- Significant amounts of tuning required to get accurate proxies now.
- Automating the process will be helpful for deployment of our proxy generation tools (Intel project objective).

# References

- ISCA 2004 - “Control Flow Modeling in Statistical Simulation for Accurate and Efficient Processor Design Studies” , Lieven Eeckhout, Robert Bell Jr., Bastiaan Stougie, Koen De Bosschere, Lizy K. John [pdf](#)
- ICS 2005 - “Improved Automatic Test case Synthesis for Performance Model Validation” , Robert H. Bell, Jr. and Lizy K. John .
- IISWC 2005 - “Efficient Power Analysis using Synthetic Testcases” , Robert H. Bell and Lizy K. John [pdf](#)
- IISWC 2006 - "Performance Cloning: A Technique for Disseminating Proprietary Applications as Benchmarks", Ajay Joshi, Lieven Eeckhout, Robert H. Bell Jr., and Lizy K. John [pdf](#)
- [ISPASS2006] Robert H. Bell, Rajiv R. Bhatia, Lizy John, Jeff Stuecheli, Ravel Thai, John Griswell, Paul Tu, Louis Capps, Anton Blanchard, “Automatic Testcase Synthesis and Performance Model Validation for High-Performance PowerPC Processors” , Proceedings of the International Symposium on Performance Analysis of Systems and Software (ISPASS), March 2006, pp. 154-165.

# References

- **[HPCA2008] A. Joshi, L. Eeckhout, L. K. John, and C. Isen, “Automated Microprocessor Stressmark Generation”, Proceedings of the IEEE International High Performance Computer Architecture (HPCA) Symposium, 2008, pp. 229-239.**
- **[ISPASS2010] Karthik Ganesan, Jungho Jo, and Lizy K. John, “Synthesizing Memory-Level Parallelism Aware Miniature Clones for SPEC CPU2006 and ImplantBench Workloads”, 2010 International Symposium on Performance Analysis of Systems and Software. ISPASS, March 2010.**
- **[TC 2014] Karthik Ganesan and Lizy K. John, Automatic Generation of Miniaturized Synthetic Proxies for Target Applications to Efficiently Design Multicore Processors, IEEE Transactions on Computers, Vol. 63, No. 4, pp. 833-846, April 2014**
- **[PACT 2017] Reena Panda and Lizy K. John, Proxy Benchmarks for Emerging Workloads, International Conference on Parallel Architectures and Compilation Techniques (PACT), September 2017**

# References

- **[SAMOS] Reena Panda, Xinnian Zheng, Jee Ho Ryoo, Michael LeBeane, Shuang Song, Andreas Gerstlauer, and Lizy K. John, “Genesys: Automatically Generating Representative Training-sets”, The IEEE International Conference on Embedded Computer Systems: Architectures, Modeling, and Simulation (SAMOS). July 2016**
- **[GLSVLSI17] S. Song, R. Desikan, M. Barakat, S. Sundaram, A. Gerstlauer, L. K. John, Fine-Grain Program Snippets generator for Mobile Core Design,” Proceedings of the Great Lakes Symposium on VLSI, GLSVLSI, May 2017**
- **[ISPASS2017] Reena Panda, Xinnian Zheng, and Lizy K. John, “ Accurate Address Streams for LLC and Beyond (SLAB): A Methodology to Enable System Exploration”, International Symposium on Performance Analysis of Systems and Software (ISPASS), April 2017**
- **[DAC2017] Reena Panda, Xinnian Zheng, Jiajun Wang, Andreas Gerstlauer, and Lizy K. John, “Statistical Pattern Based Modeling of GPU Memory Access Streams”, IEEE/ACM Design Automation Conference (DAC). June 2017.**

# References

- Rob Bell, Ph. D Dissertation, UT Austin 2005, **Automatic Workload Synthesis for Early Design Studies and Performance**
- Ajay Joshi, Ph. D Dissertation, UT Austin 2008, **Constructing Adaptable and Scalable Synthetic Benchmarks for Microprocessor Performance Evaluation**
- Karthik Ganesan, Ph. D dissertation, UT Austin 2012, **Automatic Generation of Synthetic Workloads for Multicore Systems**
- Reena Panda, Ph. Dissertation, UT Austin 2017, **Accurate Modeling of Core and Memory Locality for Proxy Generation Targeting Emerging Applications and Architectures**





The University of Texas at Austin

[lca.ece.utexas.edu](http://lca.ece.utexas.edu)

# BACK UP

## Branch bit vectors

- Need a lightweight way to specify taken/transition rates of a branch
  - Minimize computational overhead to avoid skewing results
- Solution: Compare a 1-hot shift register against a static 32 bit vector
  - High transition rate branches use a register that shifts every iteration
  - Low transition rate branches use a register that shifts every 32 iterations
  - Branch if zero flag not set (both vectors had a 1 in the same position)
- Examples (using short vectors):
  - 11001100: 50% taken rate, 50% transition rate (1.6% with slow shift register)
  - 11101110: 75% taken rate, 50% transition rate
  - 10101010: 50% taken rate, 100% transition rate
  - 10000000: 12.5% taken rate, 25% transition rate

# Generation Process

- Generate vector with target number of transitions
  - Roughly equal-sized groups of 0s and 1s, roughly 50% taken rate
- Flip bits to match target taken rate, without impacting transition rate
  - $V[n]$  can be flipped if  $V[n-1] \neq V[n+1]$
  - Example: 11110000 and 11100000 have the same transition rate
- Randomize the vector
  - Perform a random rotation
  - Shuffle groups of bits without impacting transition rate
    - Example: 11011010 and 11010110 have the same transition rate

# COMPARISON WITH STANDARD BENCHMARKS

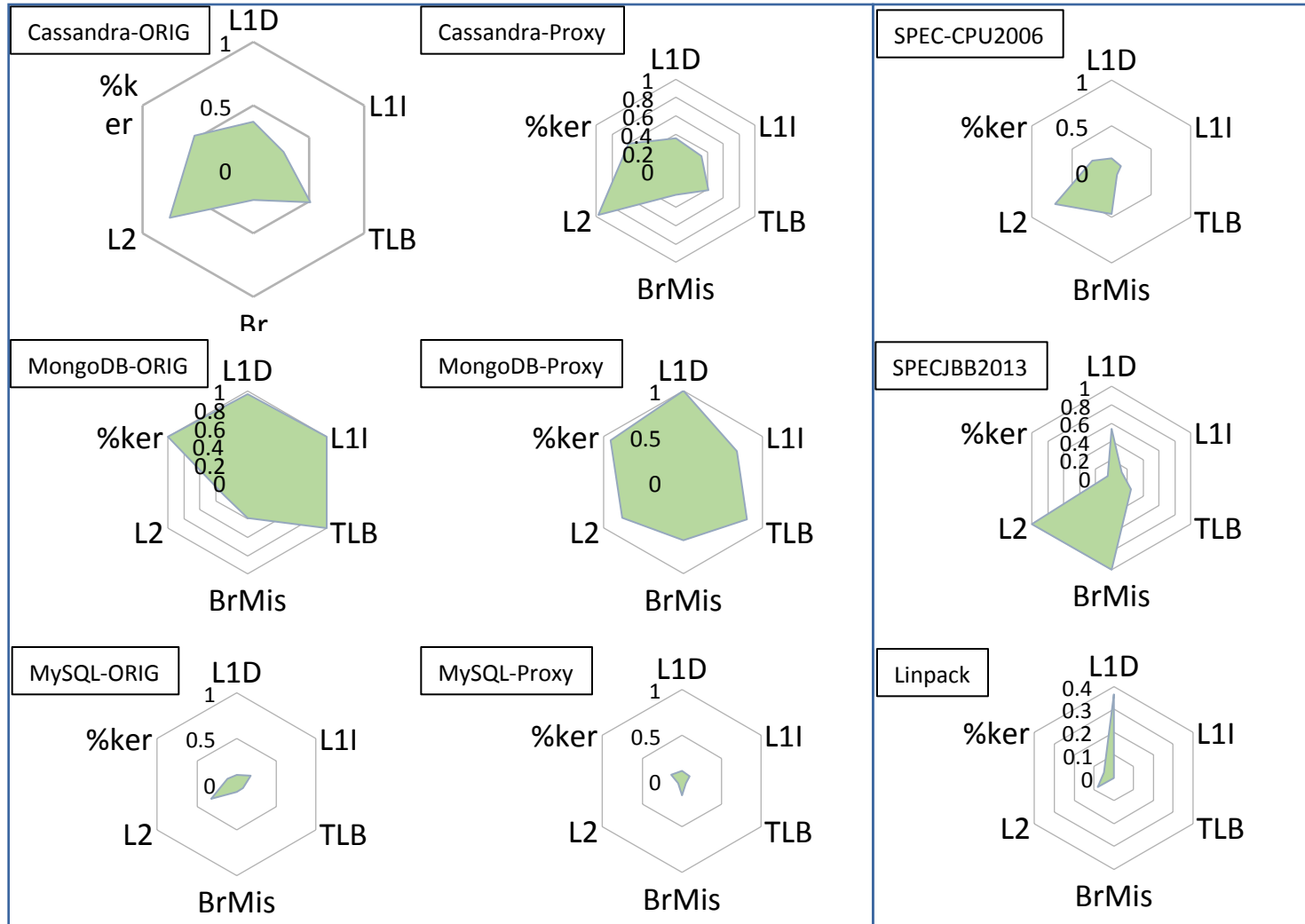

To add:

Which 5 are good from Intel

Ajay's reuse distance definition slides

SPARC MAMPO results

MAMPO cite

IISWC 2006 – proprietary reference

SYMPO reference

Find other efforts

Incorporate Steven's results – Intel results?

3 steps – Intel confidential??

# Branch Errors

Workload	BRPR MPKI error			
	Global Transition and Taken Rate (v3)	Local Transitions and Taken Rate (v4)	Local info with <b>complete correlation</b> (bv4)	Local info with <b>half correlation</b> (bv4b)
gcc	4518%	5242%	40%	1203%
perlbench	805%	-49%	-75%	256%
mcf	-100%	-100%	-99%	-99%
cactus	364%	49%	-98%	-95%
povray	1675%	1330%	-16%	49%
absolute average	(no gcc) 736%	(no gcc) 382%	66%	263%

# Industry Use

IBM – 2006

AMD – 2010

Motivating example where proxies were tuned for one platform then transferred to another platform

On Platform 1 10/10 proxies <13% IPC error versus complete benchmark

On Platform 2 5/10 proxies <13% IPC error, 5/10 proxies >37% IPC error